

# **BODENTECHNIK**

*FLOORING TECHNOLOGY*

## **PROFILE**

*PROFILES*

## Unternehmensporträt

### Historie

Mit dem 1981 gegründeten Unternehmen verwirklichte Dieter und Rosmarie Roll ihre Selbstständigkeit und starteten im schwäbischen Sonnenbühl mit einem Einzelunternehmen in der Fußbodenbranche. 1983 wurde mit damals 4 Mitarbeitern zur Roll GmbH umfirmiert. Seit 1987 befindet sich das Unternehmen in eigenen Räumen und agiert auf 2000m<sup>2</sup> Fläche. Heute sind 20 Mitarbeiter täglich für die Bedürfnisse der Kunden im In- und Ausland tätig.

### Vertrieb

Die Roll GmbH vertreibt ihre Produkte über Groß- und Fachhändler in über 30 Länder weltweit. Das qualifizierte Team, die Flexibilität und die Zuverlässigkeit sind Vorteile, die Kunden im In- und Ausland am Unternehmen schätzen.

### Produkte

Neben einem Komplettsystem an professionellen Maschinen und Werkzeugen zur Fußbodenbearbeitung bietet die Roll GmbH ein marktführendes Fußbodenprofileprogramm in gehobener Qualität an. Neben den rund 850 Standardprofilen bietet die ROLL GmbH auch Sonderanfertigungen für individuelle Großprojekte an.

### Zukunft

Die Roll GmbH ist mit vollzogenem Generationswechsel und einem motivierten Team bereit für die Zukunft. „Nicht still zustehen“ ist eine der Devisen, so auch der Slogan... Roll bringt Bewegung in's Werkzeug!



## Herstellung Fußbodenprofile

Die Herstellung der ROLL Fußbodenprofile erfolgt nach ISO 9001.

**Aluminium eloxiert:** Aluminiumprofile werden nach dem Extrusionsverfahren hergestellt. Nach dem Pressen wird das Rohmaterial im chemischen Verfahren (Eloxalbad) beschichtet und so gegen Korrosion geschützt. Die Eloxalschicht beträgt ca. 20µm. Das ROLL Sortiment umfasst 4 Standardfarben: silber glänzend, gold, dunkel bronze, edelstahloptik. Durch die vorausgehende Polierung der silber eloxierten Profile ergibt sich eine besonders ästhetisch glänzende Oberfläche. Durch die verschiedenen Eloxalfarben wird eine Vielzahl dekorativer und individueller Einsatzgebiete ermöglicht.

**Aluminium natur:** diese Profile werden nach dem Pressen nicht weiterverarbeitet sondern pressblank verlegt. Durch die pure Aluminiumoptik ergeben sich neue moderne Verlegemöglichkeiten

**Edelstahl (V2A):** Edelstahlprofile werden aus Edelstahlbändern gewalzt und geformt und sind daher nicht identisch zu Aluminium- oder Messingprofilen. Edelstahl ist mechanisch und chemisch beständig und wird daher vor allem in Bereichen erhöhter chemischer Belastung verlegt z.B. in Küchen, Molkereien, Brauereien etc. Das ROLL Sortiment umfasst hochglänzende Edelstahlprofile.

**Messing:** Messingprofile werden nach dem Extrusionsverfahren hergestellt und sind daher härter als gewalzte Messingprofile, sie sind mechanisch und chemisch beständig und daher vor allem bei hoch frequentierten Bereichen empfohlen. Einsatz im Innen- und Außenbereich möglich. Durch Feuchtigkeit kann Messing oxidieren und so nachdunkeln; diese Oxidationsschicht lässt sich jedoch mit handelsüblichen Poliermitteln wieder entfernen.

**Holzdekorprofile:** Aluminiumprofile werden zuerst farblich pulverbeschichtet und anschließend mit exklusiven PVC-Folien ummantelt. Die abriebfeste Folie dient dem dekorativen Einsatz in Verbindung mit Holzböden und ist in 4 Dekoren – buche, eiche, ahorn, und kirsch erhältlich.

**Verpackung:** ROLL Profile sind jeweils mit 10 Längen in Kartonrohre verpackt und sind so ideal für die Lagerung beim Groß- und Fachhandel.

**SB-Verpackung:** 90cm Profile, sowie Parkett- und Laminatsystemprofile werden, jeweils mit Schrauben und Dübeln geschrumpft angeboten. 90cm Profile werden inkl. Reiter für Regalaufhängung angeboten.

## Company profile

### History

In 1981 Dieter and Rosmarie Roll started their own business in the industry of flooring technology. In 1983 they founded the company named ROLL GmbH with 4 employees. Since 1987 the family business has been operating on its own premises of 2000m<sup>2</sup>. A team of 20 employees are dedicated to serve customers in Germany and in foreign countries.

### Sales and distribution

Roll GmbH sells its products to wholesalers and specialist dealers in over 30 countries worldwide. Such criteria as a well-qualified sales team, reliability, delivery service and flexibility have made the company a much valued partner.

### Products

Roll GmbH offers a premium range of flooring profiles, as well as a complete system of professional machines and tools for the flooring industry. Besides the standard range of round about 850 profiles ROLL GmbH offers also special designed profiles upon request.

### Future prospect

A new generation and a highly motivated team safeguard the future of Roll GmbH. Furthermore, steady innovations enable the company to live up to its slogan "Roll sets tools rolling!"

## Manufacturing flooring profiles

Roll flooring profiles are produced according to ISO 9001.

**Aluminium anodized:** Aluminium profiles are produced in an extrusion process. Due to chemical coating after pressing (anodizing bath) the profiles are protected against corrosion. Anodized coating approx. 20µm. Roll flooring profiles consist of 4 standard colours: silver bright, gold, dark bronze, stainless steel colour. The colour "silver bright" offers a very aesthetic shiny surface as a result of previous polishing. Due to the different colours there is a wide field of decorative and individual applications.

**Aluminium nature:** After pressing these profiles get no further treatment. Due to the pure Aluminium optic new ways of modern applications are possible.

**Stainless steel (V2A):** Profiles of stainless steel are made of belts which are rolled and formed and which are therefore different from extruded profiles. Stainless steel is mechanically and chemically resistant and thus can be used e.g. in kitchens, creameries, breweries etc. ROLL stainless steel profiles are high-gloss finished.

**Brass:** Brass profiles are made in an extrusion process and are much harder than rolled brass profiles. Brass is mechanically and chemically resistant and thus recommended for highly frequented areas, for indoors and outdoors. Due to oxidation in conjunction with moisture brass profiles can darken; this layer can be removed with customary polishing liquid.

**Profiles with wooden veneers:** Firstly, extruded aluminium profiles are powder coated in similar colours and afterwards surrounded with exclusive PVC foils. Those decorative foils are resistant to abrasion and are available in 4 colours – beech, oak, maple and cherry.

**Package:** ROLL profiles are packed in carton tubes, 10 bars each and thus ideal for storage.

**DIY package:** 90cm profiles as well as parquet and laminate system profiles are offered shrink wrapped, together with screws and dowels. Furthermore 90cm profiles have hangers to put them up in storage racks.

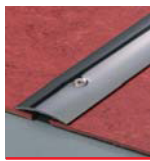

Übergangprofil  
*Cover Strips*

2



Abschlussprofile  
*Edge Trims*

9



Parkettprofile  
*Parquet Edge Trims*

13

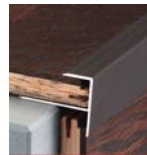

Parkett U-Profil  
*Parquet U-profiles*

15



Parkettssystemprofile zum Schrauben  
*Parquet system profiles for screwing*

19

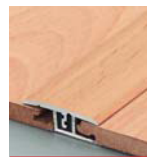

Parkettssystemprofile zum Clipsen  
*Parquet system profiles with clips*

25

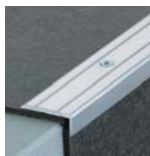

Winkelprofile  
*Angle Edges*

27



Treppenkantenprofile  
*Stair Nosings*

31



Treppenkantenprofil mit LED  
*Stair Nosings with LED*

32



Treppenkantenprofile mit Einlage  
*Stair Nosings with inserts*

35



Estrichprofile  
*Angle Edges for tiles*

37



Dehnfugenprofile  
*Expansion Joint Profile*

38



Biegbare Estrichprofile  
*Flexible Angle Edges*

39

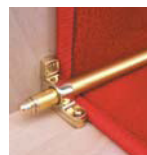

Treppenläuferzubehör  
*Stairrods and accessories*

40

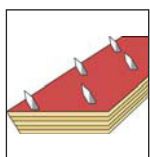

Reparaturwinkel und Nagelleisten  
*Metal angle and Gripper*

42



Antirutschklebeband  
*Antislipping tape*

43



Schrauben und Kleber  
*Screws and Assembly adhesive*

43



Verkaufsständer  
*Sales stand for profiles*

44



# Nahtdeckprofile



# Cover Strips



## Übergangsprofil und Einfassprofil 10mm Cover strip and U-profile 10mm

Filigranes Übergangsprofil mit doppelter Einfassung für anschließende Beläge gleicher Höhe bis 3,5mm z.B. Lino und PVC. Auf beiden Seiten gebohrt und gesenkt. Länge 270cm.  
*Light cover strip joining two floor coverings of equal height up to 3,5mm e.g. lino and PVC. Both sides drilled and countersunk. Length 270cm.*

**Art.nr.**  
No.

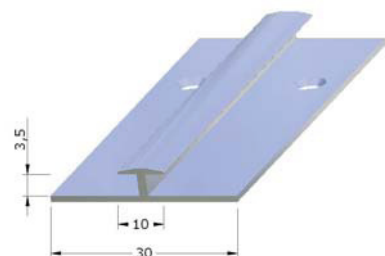

**10 x 270cm**

**Alu natur** *Alu nature*

11.10195

## T-Profil 14mm T-profile 14mm

T-Profil als Übergangsprofil und Trennprofil zur nachträglichen Verlegung zwischen Beläge gleicher Höhe. Ungebohrtes Profil, wird mit Montagekleber Art.nr. 18.12985 verlegt. Stabile Ausführung, 1,5mm dick. Profil eignet sich auch zum Biegen für runde Formen. Länge 250cm. *T-Profile covers two floorings of equal height, for subsequent laying. Undrilled, can be fixed with adhesive no. 18.12985. Robust profile 1,5mm thick, can also be bent for round shapes. Length 250cm.*

**Art.nr.**  
No.

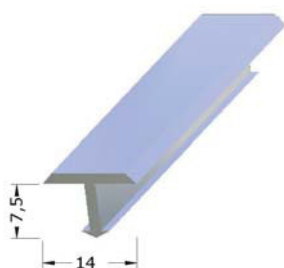

**10 x 250cm**

**Alu natur** *Alu nature*  
**Messing** *Brass*

11.15310

11.15315

## T-Profil 25mm T-profile 25mm

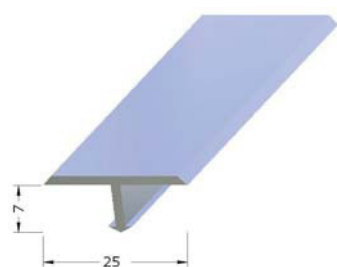

**Art.nr.**  
No.

**10 x 250cm**

**Alu natur** *Alu nature*  
**Messing** *Brass*

11.15320

11.15325

## Nahtdeckprofil 20mm Cover Strip 20mm

Übergangsprofil zwischen Belägen und Räumen. Stabile Ausführung in 1,8mm Dicke. Gebohrt und gesenkt. Länge 270cm oder 90cm in SB-Verpackung. *Profile covers two floorings. Robust profile 1,8mm thick. Drilled and countersunk. Length 270cm or 90cm in DIY-package.*

**Art.nr.**  
No.

**Art.nr. SB**  
No. *DIY*

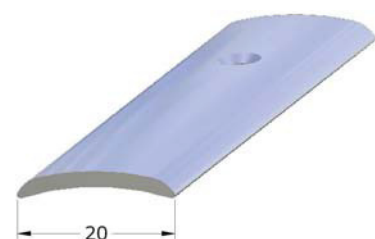

**10 x 270cm**

**Alu silber** *Alu silver*

11.10464

**10 x 90cm**

11.12066

Andere Farben auf Anfrage!  
*Other colours upon request!*

Verpackungseinheit: 10 Stangen; SB-Verpackung inkl. Schrauben und Dübel, geschumpft  
*Packing unit: 10 bars; DIY packing: screws and dowels included, shrink wrapped*

## Nahtdeckprofil 25mm Cover Strip 25mm

Übergangsprofil zwischen Belägen und Räumen. Mit Zierrillen. Stabile Ausführung, 2,1mm dick mit Zwischenstegen. Gebohrt und gesenkt. Länge 270cm oder 90cm in SB-Verpackung. Profile covers two floorings. Robust profile 2,1mm thick with bridges, fluted. Drilled and countersunk. Length 270cm or 90cm in DIY-package.

**Art.nr.**  
No.

**Art.nr. SB**  
No. DIY

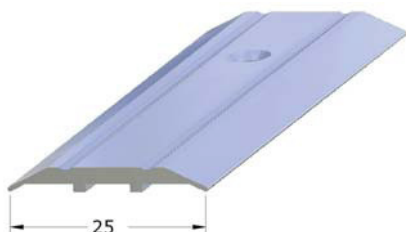

**10 x 270cm**

**10 x 90cm**

<b>Alu silber</b> <i>Alu silver</i>	11.10480
<b>Alu gold</b> <i>Alu gold</i>	11.10490

11.12070
11.12072

Alu bronze auf Anfrage!  
*Alu bronze upon request!*

## Nahtdeckprofil 25mm selbstklebend Cover Strip 25mm self-adhesive

Selbstklebend, mit 2 hochwertigen, transparenten Kleberschnüren. Self-adhesive, with two transparent premium adhesive laces.

**Art.nr.**  
No.

**Art.nr. SB**  
No. DIY

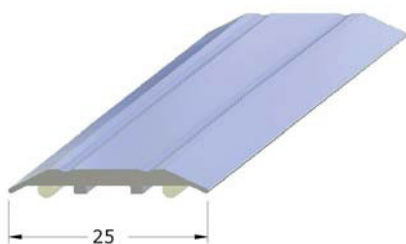

**10 x 270cm**

**10 x 90cm**

<b>Alu silber</b> <i>Alu silver</i>	11.10481
<b>Alu gold</b> <i>Alu gold</i>	11.10491

11.12071
11.12073

## Vari - Übergangprofil Cover Strip "Zig-Zag"

Variabel einsetzbares Übergangprofil zwischen Belägen gleicher oder unterschiedlicher Höhe. Auch als Abschlussprofil einsetzbar. Mit flexiblen Stauchzonen. Mit Zierrillen. Gebohrt und gesenkt. Länge 270cm oder 90cm in SB-Verpackung. Multi-purpose profile in height and variance, covers two floorings of equal or different heights, can also be used as Edge Trim. Adjustable by compressing. Drilled and countersunk. Length 270cm or 90cm in DIY-package.

**Art.nr.**  
No.

**Art.nr. SB**  
No. DIY



**10 x 270cm**

**10 x 90cm**

<b>Alu silber</b> <i>Alu silver</i>	11.10210
<b>Alu gold</b> <i>Alu gold</i>	11.10230
<b>Alu bronze</b> <i>Alu bronze</i>	11.10220

11.12000
11.12002
11.12004

## Vari - Übergangprofil selbstklebend Cover Strip "Zig-Zag" self-adhesive

Selbstklebend, mit 2 hochwertigen, transparenten Kleberschnüren. Self-adhesive, with two transparent adhesive laces.

**Art.nr.**  
No.

**Art.nr. SB**  
No. DIY

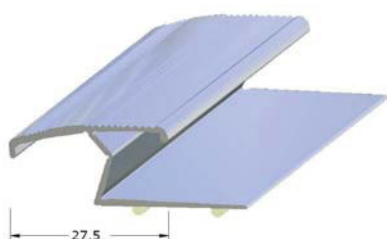

**10 x 270cm**

**10 x 90cm**

<b>Alu silber</b> <i>Alu silver</i>	11.10211
<b>Alu gold</b> <i>Alu gold</i>	11.10231
<b>Alu bronze</b> <i>Alu bronze</i>	11.10221

11.12001
11.12003
11.12005

Verpackungseinheit: 10 Stangen; SB-Verpackung inkl. Schrauben und Dübel, geschrumpft  
Packing unit: 10 bars; DIY packing: screws and dowels included, shrink wrapped

## Nahtdeckprofil 30mm Cover Strip 30mm

Übergangprofil zwischen Belägen. Robuste Ausführung Aluminium 2,2mm dick, Messing 1,25mm dick und Edelstahl 1,00mm dick. Gebohrt und gesenkt. Länge 270cm oder 90cm in SB-Verpackung. Profile covers two floorings. Robust profile aluminium: 2,2mm thick, brass: 1,25mm, stainless steel: 1,00mm. Drilled and countersunk. Length 270cm or 90cm in DIY-package.

**Art.nr.**  
No.

**Art.nr. SB**  
No. DIY

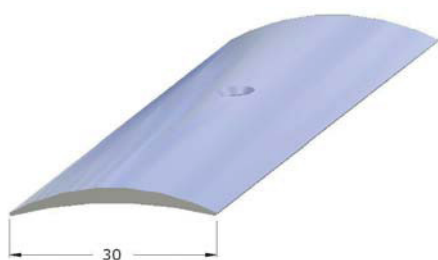

**10 x 270cm**

**10 x 90cm**

<b>Alu silber</b> <i>Alu silver</i>	11.10473
<b>Alu gold</b> <i>Alu gold</i>	11.10474
<b>Alu bronze</b> <i>Alu bronze</i>	11.10475
<b>Alu edelstahl</b> <i>Alu stainless steel</i>	11.10441
<b>Messing poliert</b> <i>Brass polished</i>	11.10421
<b>Edelstahl</b> <i>Stainless steel</i>	11.10431

11.12090
11.12092
11.12094
11.12096
11.12080
11.12082

## Nahtdeckprofil 30mm ungebohrt Cover Strip 30mm undrilled

Ungebohrt. Befestigung mit Montagekleber Art.nr. 18.12985.  
Undrilled, assembly with adhesive no. 18.12985.

**Art.nr.**  
No.

**Art.nr. SB**  
No. DIY

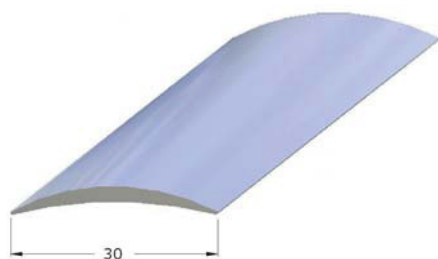

**10 x 270cm**

**10 x 90cm**

<b>Alu silber</b> <i>Alu silver</i>	11.10514
<b>Alu gold</b> <i>Alu gold</i>	11.10515
<b>Alu bronze</b> <i>Alu bronze</i>	11.10516
<b>Alu edelstahl</b> <i>Alu stainless steel</i>	11.10511
<b>Buche</b> <i>Beach</i>	11.17100
<b>Ahorn</b> <i>Maple</i>	11.17102
<b>Eiche</b> <i>Oak</i>	11.17104
<b>Kirsch</b> <i>Cherry</i>	11.17106

11.12123
11.12125
11.12127
11.12118
11.12114
11.12115
11.12116
11.12117

mit Holzdekor  
with wooden veneers

## Nahtdeckprofil 30mm selbstklebend Cover strip 30mm self-adhesive

Selbstklebend, mit 2 hochwertigen, transparenten Kleberschnüren.  
Self-adhesive, with 2 premium, transparent adhesive laces.

**Art.nr.**  
No.

**Art.nr. SB**  
No. DIY

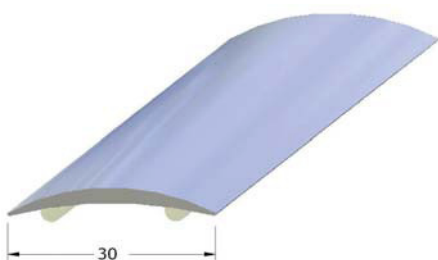

**10 x 270cm**

**10 x 90cm**

<b>Alu silber</b> <i>Alu silver</i>	11.10724
<b>Alu gold</b> <i>Alu gold</i>	11.10725
<b>Alu bronze</b> <i>Alu bronze</i>	11.10726
<b>Alu edelstahl</b> <i>Alu stainless steel</i>	11.10722
<b>Messing poliert</b> <i>Brass polished</i>	11.10712
<b>Edelstahl</b> <i>Stainless steel</i>	11.10714
<b>Buche</b> <i>Beach</i>	11.17120
<b>Ahorn</b> <i>Maple</i>	11.17122
<b>Eiche</b> <i>Oak</i>	11.17124
<b>Kirsch</b> <i>Cherry</i>	11.17126

11.12124
11.12126
11.12128
11.12119
11.12120
11.12122
11.12110
11.12111
11.12111
11.12113

mit Holzdekor  
with wooden veneers

## Nahtdeckprofil 36mm Cover Strip 36mm

Besonders flaches Übergangprofil zwischen Belägen. Mit Zierrillen. Robuste Ausführung 2,5mm dick. Gebohrt und gesenkt. Länge 270cm oder 90cm in SB-Verpackung. *Flat profile covers two floorings, fluted. Robust profile 2,5mm thick. Drilled and countersunk. Length 270cm or 90cm in DIY-package.*

**Art.nr.**  
No.

**Art.nr. SB**  
No. DIY

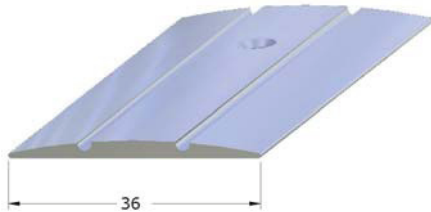

**10 x 270cm**

**10 x 90cm**

<b>Alu silber</b> <i>Alu silver</i>	11.10472
<b>Alu gold</b> <i>Alu gold</i>	11.10470
<b>Alu bronze</b> <i>Alu bronze</i>	11.10471
<b>Alu edelstahl</b> <i>Alu stainless steel</i>	11.10284

11.12134
11.12130
11.12132
11.12129

## Nahtdeckprofil 36mm selbstklebend Cover strip 36mm self-adhesive

Selbstklebend, mit 2 hochwertigen, transparenten Kleberschnüren. *Self-adhesive, with 2 premium, transparent adhesive laces.*

**Art.nr.**  
No.

**Art.nr. SB**  
No. DIY

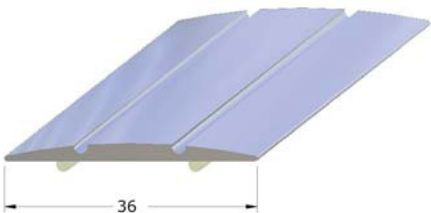

**10 x 270cm**

**10 x 90cm**

<b>Alu silber</b> <i>Alu silver</i>	11.10282
<b>Alu gold</b> <i>Alu gold</i>	11.10280
<b>Alu bronze</b> <i>Alu bronze</i>	11.10281
<b>Alu edelstahl</b> <i>Alu stainless steel</i>	11.10286
<b>Buche</b> <i>Beach</i>	11.17200
<b>Ahorn</b> <i>Maple</i>	11.17202
<b>Eiche</b> <i>Oak</i>	11.17204
<b>Kirsch</b> <i>Cherry</i>	11.17206

11.12137
11.12136
11.12138
11.12121
11.12131
11.12133
11.12135
11.12139

**mit Holzdekor**  
**with wooden veneers**

## Verlegetipp – bei schlechten Untergründen The straight tip – for subsurfaces in a bad state

Bei der Verlegung von gebohrten Profilen in Verbindung mit Belägen ab 6mm Höhe kann zur Verbesserung der Gesamtkonstruktion auch ein Basisprofil (6, 9 oder 12mm Höhe) als Grundlage verlegt werden. In den Schraubkanal kann anschließend jedes beliebige gebohrte Profil befestigt werden. Länge Basisprofil 270cm. *When laying drilled profiles in conjunction with floor coverings up to 6mm we recommend to use one of our base profiles (6, 9 or 12mm height). In the screw hole you can fix any drilled profile easily. Length base profile 270cm.*

**Art.nr.**  
No.

**Art.nr.**  
No.

**Beispiel 1**  
*Example 1*

**10 x 270cm**

**Pack à 200 Stück**  
*Pack of 200 units*

<b>Alu natur 6mm</b> <i>Alu nature 6mm</i>	11.11806
<b>Alu natur 9mm</b> <i>Alu nature 9mm</i>	11.11809
<b>Alu natur 12mm</b> <i>Alu nature 12mm</i>	11.11812

**Beispiel 2**  
*Example 2*

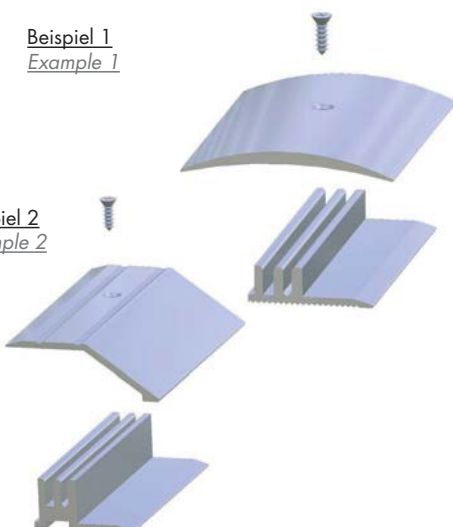

<b>Kreuzschlitzschraube vernickelt 2,9x9,5mm</b> <i>Crosshead screw nickel-plated 2,9x9,5mm</i>	21.12330B
<b>Kreuzschlitzschraube vernickelt 2,9x13mm</b> <i>Crosshead screw nickel-plated 2,9x13mm</i>	21.12332B
<b>Kreuzschlitzschraube gold 2,9x9,5mm</b> <i>Crosshead screw gold 2,9x9,5mm</i>	21.12340B
<b>Kreuzschlitzschraube gold 2,9x13mm</b> <i>Crosshead screw gold 2,9x13mm</i>	21.12342B
<b>Kreuzschlitzschraube bronze 2,9x9,5mm</b> <i>Crosshead screw bronze 2,9x9,5mm</i>	21.12350B
<b>Kreuzschlitzschraube bronze 2,9x13mm</b> <i>Crosshead screw bronze 2,9x13mm</i>	21.12352B

Verpackungseinheit: 10 Stangen; SB-Verpackung inkl. Schrauben und Dübel, geschrumpft  
*Packing unit: 10 bars; DIY packing: screws and dowels included, shrink wrapped*



## Nahtdeckprofil 40mm Cover Strip 40mm

Übergangprofil zwischen Belägen. Robuste Ausführung 2,0mm dick und Messing 1,5mm dick. Gebohrt und gesenkt. Länge 270cm oder 90cm in SB-Verpackung. Profile covers two floorings. Robust profile aluminium: 2,0mm thick, brass: 1,5mm. Drilled and countersunk. Length 270cm or 90cm in DIY-package.

**Art.nr.**  
No.

**Art.nr. SB**  
No. DIY

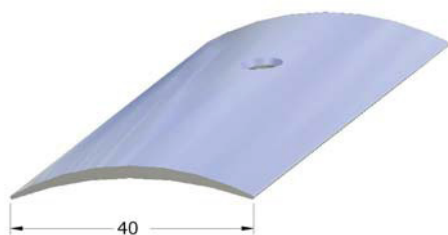

**10 x 270cm**

**10 x 90cm**

<b>Alu silber</b> <i>Alu silver</i>	11.10476
<b>Alu gold</b> <i>Alu gold</i>	11.10477
<b>Alu bronze</b> <i>Alu bronze</i>	11.10478
<b>Alu edelstahl</b> <i>Alu stainless steel</i>	11.10479
<b>Messing poliert</b> <i>Brass polished</i>	11.17410

11.12140
11.12142
11.12144
11.12149
11.12146

## Nahtdeckprofil 40mm ungebohrt Cover Strip 40mm undrilled

Ungebohrt. Befestigung z.B. mit PU-Montagekleber Art.nr. 18.12985. Undrilled. Assembly with PU-adhesive no. 18.12985.

**Art.nr.**  
No.

**Art.nr. SB**  
No. DIY

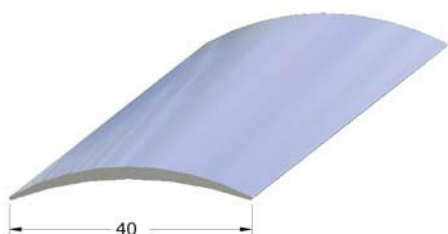

**10 x 270cm**

**10 x 90cm**

<b>Alu silber</b> <i>Alu silver</i>	11.10517
<b>Alu gold</b> <i>Alu gold</i>	11.10513
<b>Alu bronze</b> <i>Alu bronze</i>	11.10518
<b>Alu edelstahl</b> <i>Alu stainless steel</i>	11.10519
<b>Buche</b> <i>Beach</i>	11.17220
<b>Ahorn</b> <i>Maple</i>	11.17222
<b>Eiche</b> <i>Oak</i>	11.17224
<b>Kirsch</b> <i>Cherry</i>	11.17226

11.12141
11.12143
11.12145
11.12151
11.12050
11.12051
11.12052
11.12053

**mit Holzdekor**  
*with wooden veneers*

## Nahtdeckprofil 40mm selbstklebend Cover Strip 40mm self-adhesive

Selbstklebend, mit 2 hochwertigen, transparenten Kleberschnüren. Self-adhesive, with 2 premium, transparent adhesive laces.

**Art.nr.**  
No.

**Art.nr. SB**  
No. DIY

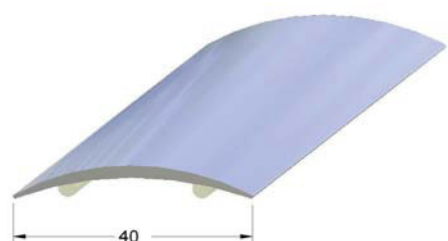

**10 x 270cm**

**10 x 90cm**

<b>Alu silber</b> <i>Alu silver</i>	11.10716
<b>Alu gold</b> <i>Alu gold</i>	11.10717
<b>Alu bronze</b> <i>Alu bronze</i>	11.10718
<b>Alu edelstahl</b> <i>Alu stainless steel</i>	11.10730
<b>Messing poliert</b> <i>Brass polished</i>	11.10728
<b>Buche</b> <i>Beach</i>	11.17230
<b>Ahorn</b> <i>Maple</i>	11.17232
<b>Eiche</b> <i>Oak</i>	11.17234
<b>Kirsch</b> <i>Cherry</i>	11.17236

11.12150
11.12152
11.12154
11.12148
11.12147
11.12055
11.12056
11.12057
11.12058

**mit Holzdekor**  
*with wooden veneers*

## Nahtdeckprofil 50mm – Industrieprofil Cover Strip 50mm – industrial profile

Übergangprofil zwischen Belägen, auch als Schutz- und Stoßleiste an Wänden. Robuste Ausführung 3,0mm dick, staplergeeignet. Gebohrt und gesenkt. Länge 270cm oder 90cm in SB-Verpackung. Profile covers two floorings, can also be used as a protection strip on walls. Robust profile 3,0mm thick, fork lift proof. Drilled and countersunk. Length 270cm or 90cm in DIY-package.

Art.nr.  
No.

Art.nr. SB  
No. DIY

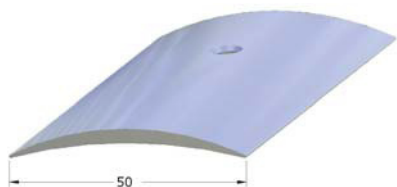

**Alu silber** *Alu silver*  
**Alu edelstahl** *Alu stainless steel*

**10 x 270cm**

**10 x 90cm**

11.10445  
11.10447

11.12157  
11.12159

## Nahtdeckprofil 50mm ungebohrt – Industrieprofil Cover Strip 50mm undrilled – industrial profile

Ungebohrt. Befestigung z.B. mit PU-Montagekleber Art.nr. 18.12985. Undrilled. Assembly with PU-adhesive no. 18.12985

Art.nr.  
No.

Art.nr. SB  
No. DIY

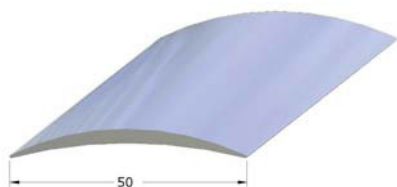

**Alu silber** *Alu silver*  
**Alu edelstahl** *Alu stainless steel*

**10 x 270cm**

**10 x 90cm**

11.10444  
11.10446

11.12156  
11.12158

## Nahtdeckprofil 60mm ungebohrt – Industrieprofil Cover Strip 60mm undrilled – industrial profile

Übergangprofil zwischen Belägen und über Dehnfugen, auch als Schutz- und Stoßleiste an der Wand. Robuste Ausführung mit Zwischenstegen. Staplergeeignet. Ungebohrt, Befestigung z.B. mit PU-Montagekleber Art.nr. 18.12985. Länge 300cm oder 100cm in SB-Verpackung. Profile covers two floorings and expansion joints, can also be used as protection strip on walls. Robust profile with bridges, fork lift proof. Undrilled, assembly with PU-adhesive no. 18.12985. Length 300cm or 100cm in DIY-package.

Art.nr.  
No.

Art.nr. SB  
No. DIY

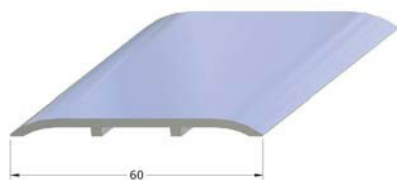

**Alu silber** *Alu silver*  
**Alu edelstahl** *Alu stainless steel*

**10 x 300cm**

**10 x 100cm**

11.10582  
11.10584

11.12100  
11.12102

## Nahtdeckprofil 80mm ungebohrt – Industrieprofil Cover Strip 80mm undrilled – industrial profile

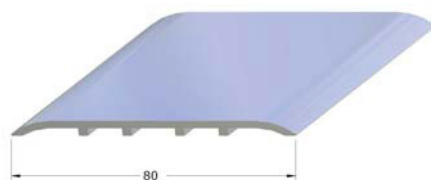

**Alu silber** *Alu silver*  
**Alu edelstahl** *Alu stainless steel*

Art.nr.  
No.

Art.nr. SB  
No. DIY

**10 x 300cm**

**10 x 100cm**

11.10585  
11.10587

11.12104  
11.12106

## Nahtdeckprofil 100mm ungebohrt – Industrieprofil Cover Strip 100mm undrilled – industrial profile

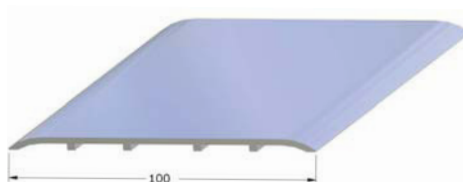

**Alu silber** *Alu silver*  
**Alu edelstahl** *Alu stainless steel*

Art.nr.  
No.

Art.nr. SB  
No. DIY

**10 x 300cm**

**10 x 100cm**

11.10592  
11.10594

11.12108  
11.12109

# Abschlussprofile

# Edge Trims



## Abschlussprofil 2,6mm Edge Trim 2,6mm

Abschlussprofil zu Lino, PVC und Kork bis 2,6mm. Gebohrt und gesenkt. Länge 270cm oder 90cm in SB-Verpackung. Robust edge trim for lino, PVC and cork up to 2,6mm. Drilled and countersunk. Length 270cm or 90cm in DIY-package.

**Art.nr.**  
No.

**Art.nr. SB**  
No. DIY

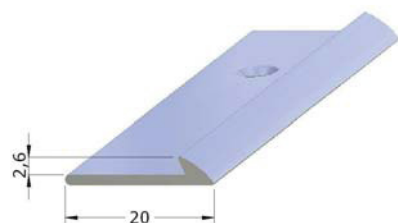

**Alu silber** *Alu silver*  
**Messing** *Brass*

**10 x 270cm**

**10 x 90cm**

11.10351  
11.10350

11.12006  
11.12008

## Abschlussprofil 5mm Edge Trim 5mm

Abschlussprofil zu Belägen bis 5mm. Durch Zusammendrücken des Abschlusses wird der Belag dauerhaft eingeklemmt. Gebohrt und gesenkt. Länge 270cm oder 90cm in SB-Verpackung. Adaptable edge trim for floor coverings up to 5mm. Drilled and countersunk. Length 270cm or 90cm in DIY-package.

**Art.nr.**  
No.

**Art.nr. SB**  
No. DIY

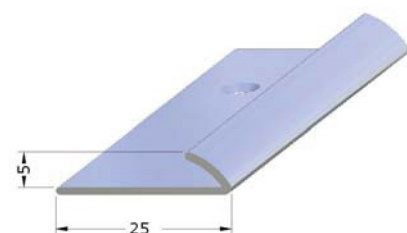

**Alu silber** *Alu silver*  
**Alu gold** *Alu gold*  
**Alu bronze** *Alu bronze*

**10 x 270cm**

**10 x 90cm**

11.10232  
11.10233  
11.10234

11.12010  
11.12012  
11.12014

## Abschlussprofil 5mm Edge Trim 5mm

Stabiler Abschluss zu Belägen bis 5mm. Gebohrt und gesenkt. Länge 270cm oder 90cm in SB-Verpackung. Robust edge trim for floor coverings up to 5mm. Drilled and countersunk. Length 270cm or 90cm in DIY-package.

**Art.nr.**  
No.

**Art.nr. SB**  
No. DIY

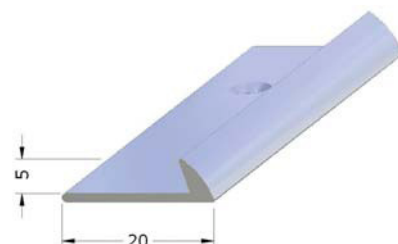

**Alu silber** *Alu silver*  
**Messing** *Brass*

**10 x 270cm**

**10 x 90cm**

11.10361  
11.10360

11.12016  
11.12018

## Sockelabschlussprofil 5mm Base Edge Trim 5mm

Abschlussprofil zu Belägen bis 5mm, mit Einschub, auch als Sockelabschluss. Mit Zier-  
rillen. Gebohrt und gesenkt. Länge 270cm oder 90cm in SB-Verpackung. Edge trim for  
floor coverings up to 5mm, with insertion, fluted. Drilled and countersunk. Length 270cm or  
90cm in DIY-package.

**Art.nr.**  
No.

**Art.nr. SB**  
No. DIY

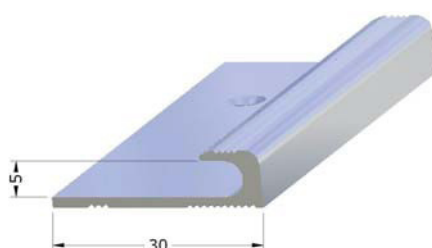

**Alu silber** *Alu silver*  
**Alu gold** *Alu gold*  
**Alu bronze** *Alu bronze*

**10 x 270cm**

**10 x 90cm**

11.11070  
11.11080  
11.11090

11.12040  
11.12042  
11.12044



### Abschlussprofil 6mm Edge Trim 6mm

Robuster Abschluss zu Belägen bis 6mm, mit Einschub, auch als Sockelabschluss geeignet. Gebohrt und gesenkt. Länge 270cm oder 90cm in SB-Verpackung. *Robust edge trim for floor coverings up to 6mm, with insertion, can also be used as baseboard. Drilled and countersunk. Length 270cm or 90cm in DIY-package.*

**Art.nr.**  
No.

**Art.nr. SB**  
No. DIY

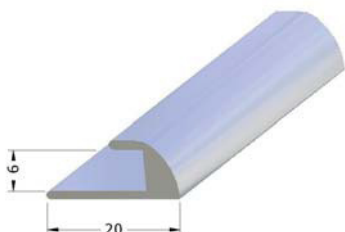

**10 x 270cm**

**10 x 90cm**

**Alu silber** *Alu silver*

11.10400

11.12026

### Abschlussprofil 8mm Edge Trim 8mm

Abschlussprofil zu Teppichbelägen. Durch Zusammendrücken des Abschlusses wird der Belag dauerhaft eingeklemmt. Gebohrt und gesenkt. Länge 270cm oder 90cm in SB-Verpackung. *Border profile for carpets, adaptable. Drilled and countersunk. Length 270cm or 90cm in DIY-package.*

**Art.nr.**  
No.

**Art.nr. SB**  
No. DIY

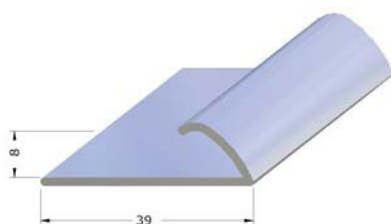

**10 x 270cm**

**10 x 90cm**

**Alu silber** *Alu silver*  
**Messing** *Brass*

11.10310

11.10270

11.12036

11.12038

### Abschlussprofil 12mm Edge Trim 12mm

Universell einsetzbarer Abschluss zu Teppichen und anderen Belägen. Durch Zusammendrücken des Abschlusses wird der Belag dauerhaft eingeklemmt. Inklusive Fixiersteg für einfachere Verlegung von Teppichen. Gebohrt und gesenkt. Länge 270cm oder 90cm in SB-Verpackung. *All-purpose edge trim for carpets and other floor coverings, adaptable. With extra strip for easy laying of carpets. Drilled and countersunk. Length 270cm or 90cm in DIY-package.*

**Art.nr.**  
No.

**Art.nr. SB**  
No. DIY



**10 x 270cm**

**10 x 90cm**

**Alu silber** *Alu silver*  
**Alu gold** *Alu gold*  
**Alu bronze** *Alu bronze*  
**Alu edelstahl** *Alu stainless steel*

11.10240

11.10250

11.10260

11.10242

11.12020

11.12022

11.12024

11.12021

### Abschlussprofil 12mm selbstklebend Edge Trim 12mm self-adhesive

Selbstklebend, mit 2 hochwertigen, transparenten Kleberschnüren. *Self-adhesive with 2 premium, transparent adhesive laces.*

**Art.nr.**  
No.

**Art.nr. SB**  
No. DIY

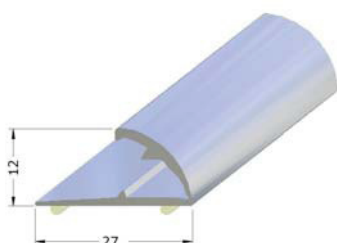

**10 x 270cm**

**10 x 90cm**

**Alu silber** *Alu silver*  
**Alu gold** *Alu gold*  
**Alu bronze** *Alu bronze*  
**Alu edelstahl** *Alu stainless steel*

11.10680

11.10690

11.10700

11.10682

11.12030

11.12032

11.12034

11.12031

Verpackungseinheit: 10 Stangen; SB-Verpackung inkl. Schrauben und Dübel, geschrumpft  
Packing unit: 10 bars; DIY packing: screws and dowels included, shrink wrapped

**Lino – Abschlussprofil 3,5mm****Lino Edge Trim 3,5mm**

Abschlussprofil zu dünnen Belägen bis 3,5mm. Mit Zierrillen. Gebohrt und gesenkt. Länge 270cm oder 90cm in SB-Verpackung. Ramp profile for thin floor coverings up to 3,5mm, fluted. Drilled and countersunk. Length 270cm or 90cm in DIY-package.

**Art.nr.**  
No.

**Art.nr. SB**  
No. DIY

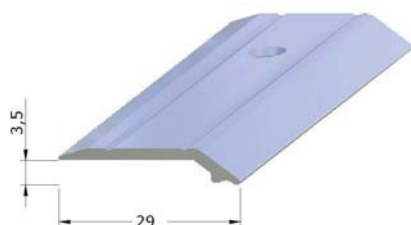

	10 x 270cm
<b>Alu silber</b> <i>Alu silver</i>	11.10551
<b>Alu gold</b> <i>Alu gold</i>	11.10552
<b>Alu bronze</b> <i>Alu bronze</i>	11.10553

	10 x 90cm
	11.12160
	11.12162
	11.12164

**Lino – Abschlussprofil 3,5mm selbstklebend****Lino Edge Trim 3,5mm self-adhesive**

Selbstklebend, mit 2 hochwertigen, transparenten Kleberschnüren. Self-adhesive with 2 premium, transparent adhesive laces.

**Art.nr.**  
No.

**Art.nr. SB**  
No. DIY

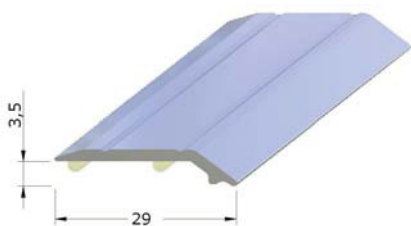

	10 x 270cm
<b>Alu silber</b> <i>Alu silver</i>	11.10555
<b>Alu gold</b> <i>Alu gold</i>	11.10556

	10 x 90cm
	11.12161
	11.12163

**Lino – Abschlussprofil 4,5mm****Lino Edge Trim 4,5mm**

Abschlussprofil zu dünnen Belägen bis 4,5mm. Mit Zierrillen. Gebohrt und gesenkt. Länge 270cm oder 90cm in SB-Verpackung. Ramp profile for thin floor coverings up to 4,5mm, fluted. Drilled and countersunk. Length 270cm or 90cm in DIY-package.

**Art.nr.**  
No.

**Art.nr. SB**  
No. DIY

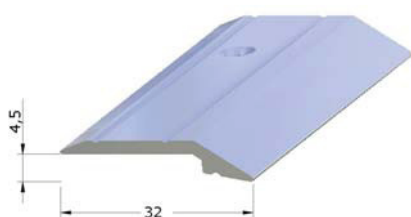

	10 x 270cm
<b>Alu silber</b> <i>Alu silver</i>	11.10520
<b>Alu gold</b> <i>Alu gold</i>	11.10530
<b>Alu bronze</b> <i>Alu bronze</i>	11.10540

	10 x 90cm
	11.12170
	11.12172
	11.12174

**Lino – Abschlussprofil 4,5mm selbstklebend****Lino Edge Trim 4,5mm self-adhesive**

Selbstklebend, mit 2 hochwertigen, transparenten Kleberschnüren. Self-adhesive with 2 premium, transparent adhesive laces.

**Art.nr.**  
No.

**Art.nr. SB**  
No. DIY

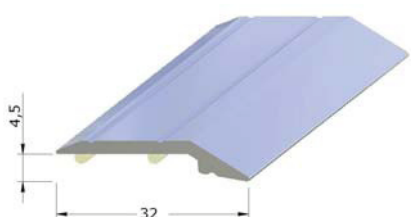

	10 x 270cm
<b>Alu silber</b> <i>Alu silver</i>	11.10521
<b>Alu gold</b> <i>Alu gold</i>	11.10531

	10 x 90cm
	11.12171
	11.12173

# Parkettprofile



# Parquet profiles



## Parkett - Abschlussprofil 8mm Parquet Edge Trim 8mm

Abschluss zu Parkett und Laminat als Ausgleich zu anderen Belagshöhen. Gebohrt und gesenkt. Mit Zierrillen. Länge 270cm oder 90cm in SB-Verpackung. Ramp profile protecting the edge of laminate and parquet against other floor coverings, fluted. Drilled and countersunk. Length 270cm or 90cm in DIY-package.

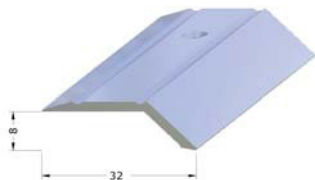

Art.nr.  
No.

Art.nr. SB  
No. DIY

10 x 270cm

10 x 90cm

Alu silber <i>Alu silver</i>	11.11400
Alu gold <i>Alu gold</i>	11.11410

11.12180
11.12182

## Parkett - Abschlussprofil 8mm selbstklebend Parquet Edge Trim 8mm self-adhesive

Selbstklebend, mit 2 hochwertigen, transparenten Kleberschnüren. Siehe auch Parkett-Abschlussprofil 10mm und 15mm. Self-adhesive, with 2 premium, transparent adhesive laces. Please compare 10mm and 15mm.



Art.nr.  
No.

Art.nr. SB  
No. DIY

10 x 270cm

10 x 90cm

Alu silber <i>Alu silver</i>	11.11401
Alu gold <i>Alu gold</i>	11.11411
Buche <i>Beach</i>	11.17280
Ahorn <i>Maple</i>	11.17281
Eiche <i>Oak</i>	11.17282
Kirsch <i>Cherry</i>	11.17283

11.12181
11.12183
11.12184
11.12185
11.12186
11.12187

## Parkett - Abschlussprofil 10mm Parquet Edge Trim 10mm



Art.nr.  
No.

Art.nr. SB  
No. DIY

10 x 270cm

10 x 90cm

Alu silber <i>Alu silver</i>	11.11439
Alu gold <i>Alu gold</i>	11.11440

11.12190
11.12192

## Parkett - Abschlussprofil 10mm selbstklebend Parquet Edge Trim 10mm self-adhesive



Art.nr.  
No.

Art.nr. SB  
No. DIY

10 x 270cm

10 x 90cm

Alu silber <i>Alu silver</i>	11.11438
Alu gold <i>Alu gold</i>	11.11441

11.12191
11.12193

## Parkett - Abschlussprofil 15mm Parquet Edge Trim 15mm



Art.nr.  
No.

Art.nr. SB  
No. DIY

10 x 270cm

10 x 90cm

Alu silber <i>Alu silver</i>	11.11470
Alu gold <i>Alu gold</i>	11.11480

11.12200
11.12202

## Parkett - Abschlussprofil 15mm selbstklebend Parquet Edge Trim 15mm self-adhesive



Art.nr.  
No.

Art.nr. SB  
No. DIY

10 x 270cm

10 x 90cm

Alu silber <i>Alu silver</i>	11.11471
Alu gold <i>Alu gold</i>	11.11481

11.12201
11.12203



## U-Profil 7,2mm für Laminat Edge Trim 7,2mm for laminate

Einschubprofil, mit großzügiger Einschubtiefe zur Übernahme von Holzbewegungen. Gebohrt und gesenkt. Länge 270cm oder 90cm in SB-Verpackung. Used to insert parquet and laminate, with high insertion depth allowing space for expansion. Drilled and counter-sunk. Length 270cm or 90cm in DIY-package.

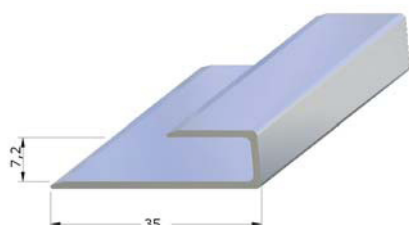

Art.nr.  
No.

Art.nr. SB  
No. DIY

10 x 270cm

10 x 90cm

Alu silber <i>Alu silver</i>	11.11690
Alu gold <i>Alu gold</i>	11.11692
Alu edelstahl <i>Alu stainless steel</i>	11.11696

11.12330
11.12332
11.12336

## U-Profil 7,2mm für Laminat selbstklebend Edge Trim 7,2mm for laminate self-adhesive

Selbstklebend, mit 2 hochwertigen, transparenten Kleberschnüren. Siehe auch U-Profil 8,2mm, 10,2mm, 11,2mm, 13,2mm, 14,2mm, 15,2mm. Self-adhesive, with 2 premium, transparent adhesive laces. Please compare U-profile 8,2mm, 10,2mm, 11,2mm, 13,2mm, 14,2mm, 15,2mm.

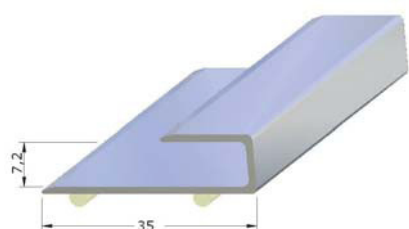

Art.nr.  
No.

Art.nr. SB  
No. DIY

10 x 270cm

10 x 90cm

Alu silber <i>Alu silver</i>	11.11691
Alu gold <i>Alu gold</i>	11.11693
Alu edelstahl <i>Alu stainless steel</i>	11.11697

11.12331
11.12333
11.12335

## U-Profil 8,2mm für Laminat Edge Trim 8,2mm for laminate

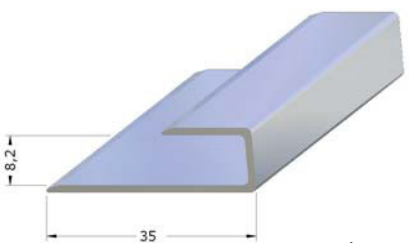

mit Holzdekor  
with wooden veneers

Art.nr.  
No.

Art.nr. SB  
No. DIY

10 x 270cm

10 x 90cm

Alu silber <i>Alu silver</i>	11.11700
Alu gold <i>Alu gold</i>	11.11702
Alu edelstahl <i>Alu stainless steel</i>	11.11698
Messing <i>Brass</i>	11.11600
Buche <i>Beach</i>	11.17300
Ahorn <i>Maple</i>	11.17301
Eiche <i>Oak</i>	11.17302
Kirsch <i>Cherry</i>	11.17303

11.12340
11.12342
11.12343
11.12344
11.22300
11.22302
11.22304
11.22306

## U-Profil 8,2mm für Laminat selbstklebend Edge Trim 8,2mm for laminate self-adhesive

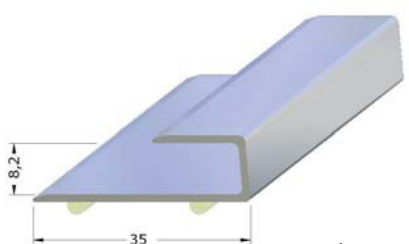

mit Holzdekor  
with wooden veneers

Art.nr.  
No.

Art.nr. SB  
No. DIY

10 x 270cm

10 x 90cm

Alu silber <i>Alu silver</i>	11.11701
Alu gold <i>Alu gold</i>	11.11703
Alu edelstahl <i>Alu stainless steel</i>	11.11706
Buche <i>Beach</i>	11.17310
Ahorn <i>Maple</i>	11.17311
Eiche <i>Oak</i>	11.17312
Kirsch <i>Cherry</i>	11.17313

11.12345
11.12346
11.12347
11.22310
11.22312
11.22314
11.22316

## U-Profil 10,2mm für Laminat und Parkett Edge Trim 10,2mm for laminate and parquet

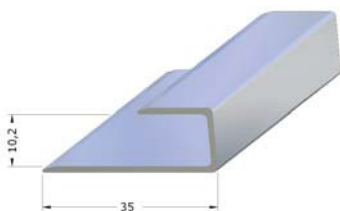

	Art.nr. No.	Art.nr. SB No. DIY
	<b>10 x 270cm</b>	<b>10 x 90cm</b>
<b>Alu silber</b> <i>Alu silver</i>	11.11710	11.12350
<b>Alu gold</b> <i>Alu gold</i>	11.11712	11.12352
<b>Alu bronze</b> <i>Alu bronze</i>	11.11714	11.12354
<b>Alu edelstahl</b> <i>Alu stainless steel</i>	11.11707	11.12353

## U-Profil 10,2mm für Laminat und Parkett selbstklebend Edge Trim 10,2mm for laminate and parquet self-adhesive

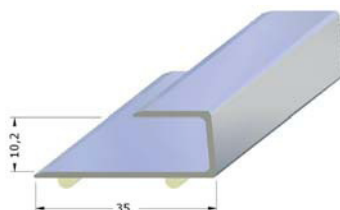

	Art.nr. No.	Art.nr. SB No. DIY
	<b>10 x 270cm</b>	<b>10 x 90cm</b>
<b>Alu silber</b> <i>Alu silver</i>	11.11709	11.12355
<b>Alu gold</b> <i>Alu gold</i>	11.11711	11.12356
<b>Alu bronze</b> <i>Alu bronze</i>	11.11713	11.12357
<b>Alu edelstahl</b> <i>Alu stainless steel</i>	11.11723	11.12358

## U-Profil 11,2mm für Laminat und Parkett Edge Trim 11,2mm for laminate and parquet

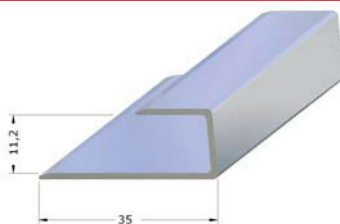

	Art.nr. No.	Art.nr. SB No. DIY
	<b>10 x 270cm</b>	<b>10 x 90cm</b>
<b>Alu silber</b> <i>Alu silver</i>	11.11715	11.12360
<b>Alu gold</b> <i>Alu gold</i>	11.11716	11.12362
<b>Alu edelstahl</b> <i>Alu stainless steel</i>	11.11708	11.12363
<b>Messing</b> <i>Brass</i>	11.11610	11.12364

## U-Profil 11,2mm für Laminat und Parkett selbstklebend Edge Trim 11,2mm for laminate and parquet self-adhesive

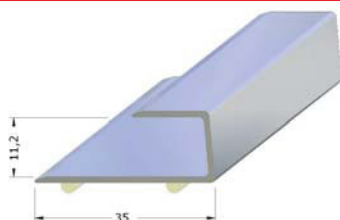

	Art.nr. No.	Art.nr. SB No. DIY
	<b>10 x 270cm</b>	<b>10 x 90cm</b>
<b>Alu silber</b> <i>Alu silver</i>	11.11717	11.12365
<b>Alu gold</b> <i>Alu gold</i>	11.11718	11.12366
<b>Alu edelstahl</b> <i>Alu stainless steel</i>	11.11719	11.12367

## U-Profil 13,2mm für Laminat und Parkett Edge Trim 13,2mm for laminate and parquet

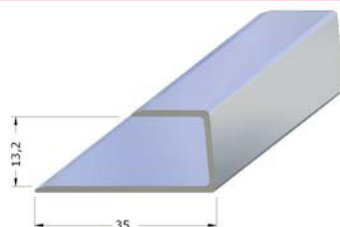

	Art.nr. No.	Art.nr. SB No. DIY
	<b>10 x 270cm</b>	<b>10 x 90cm</b>
<b>Alu silber</b> <i>Alu silver</i>	11.11720	11.12370
<b>Alu gold</b> <i>Alu gold</i>	11.11722	11.12372
<b>Alu edelstahl</b> <i>Alu stainless steel</i>	11.11721	11.12373
<b>Messing</b> <i>Brass</i>	11.11620	11.12376

## U-Profil 13,2mm für Laminat und Parkett selbstklebend Edge Trim 13,2mm for laminate and parquet self-adhesive

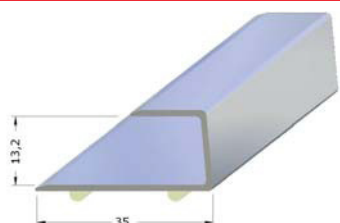

	Art.nr. No.	Art.nr. SB No. DIY
	<b>10 x 270cm</b>	<b>10 x 90cm</b>
<b>Alu silber</b> <i>Alu silver</i>	11.11680	11.12371
<b>Alu gold</b> <i>Alu gold</i>	11.11681	11.12375
<b>Alu edelstahl</b> <i>Alu stainless steel</i>	11.11682	11.12377

Verpackungseinheit: 10 Stangen; SB-Verpackung inkl. Schrauben und Dübel, geschrumpft  
Packing unit: 10 bars; DIY packing: screws and dowels included, shrink wrapped

## U-Profil 14,2mm für Laminat und Parkett Edge Trim 14,2mm for laminate and parquet

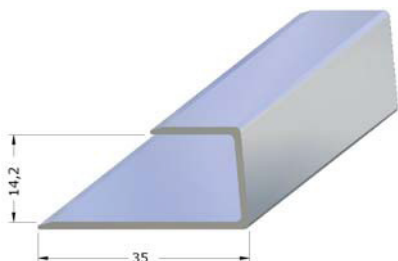

Art.nr.  
No.

Art.nr. SB  
No. DIY

10 x 270cm

10 x 90cm

<b>Alu silber</b> <i>Alu silver</i>	11.11725
<b>Alu gold</b> <i>Alu gold</i>	11.11727
<b>Alu edelstahl</b> <i>Alu stainless steel</i>	11.11726

11.12380
11.12382
11.12383

## U-Profil 14,2mm für Laminat und Parkett selbstklebend Edge Trim 14,2mm for laminate and parquet self-adhesive

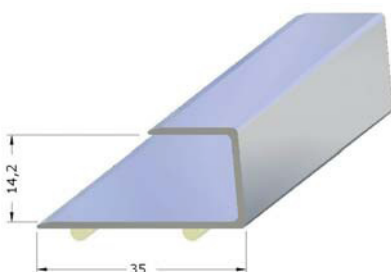

Art.nr.  
No.

Art.nr. SB  
No. DIY

10 x 270cm

10 x 90cm

<b>Alu silber</b> <i>Alu silver</i>	11.11683
<b>Alu gold</b> <i>Alu gold</i>	11.11684
<b>Alu edelstahl</b> <i>Alu stainless steel</i>	11.11685

11.12385
11.12386
11.12387

## U-Profil 15,2mm für Laminat und Parkett Edge Trim 15,2mm for laminate and parquet

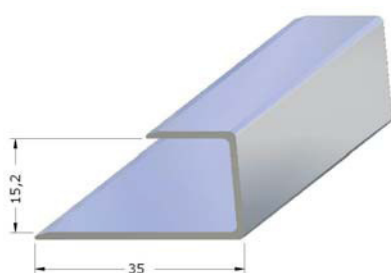

Art.nr.  
No.

Art.nr. SB  
No. DIY

10 x 270cm

10 x 90cm

<b>Alu silber</b> <i>Alu silver</i>	11.11730
<b>Alu gold</b> <i>Alu gold</i>	11.11732
<b>Alu edelstahl</b> <i>Alu stainless steel</i>	11.11728

11.12390
11.12392
11.12393

## U-Profil 15,2mm für Laminat und Parkett selbstklebend Edge Trim 15,2mm for laminate and parquet self-adhesive

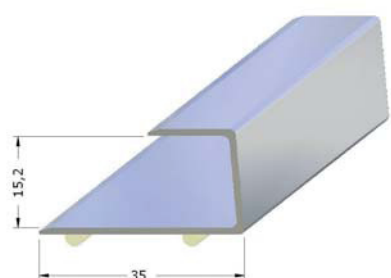

Art.nr.  
No.

Art.nr. SB  
No. DIY

10 x 270cm

10 x 90cm

<b>Alu silber</b> <i>Alu silver</i>	11.11731
<b>Alu gold</b> <i>Alu gold</i>	11.11733
<b>Alu edelstahl</b> <i>Alu stainless steel</i>	11.11735

11.12395
11.12396
11.12397

## Treppenkantenprofil 7,2mm für Laminat Stair Nosing 7,2mm for laminate

Zur Verlegung von Laminat und Parkett auf Treppen. Mit großzügiger Einschubtiefe für mögliche Holzbewegungen. Gebohrt und gesenkt. Mit Anitrutschrillen. Länge 270cm und 90cm in SB-Verpackung. Profile for laminate and parquet on stairs. With high insertion depth allowing space for expansion. Drilled and countersunk, fluted. Length 270cm and 90cm in DIY-package.

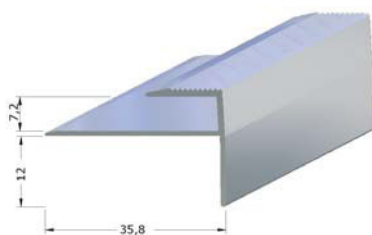

	10 x 270cm
<b>Alu silber</b> <i>Alu silver</i>	11.11740
<b>Alu gold</b> <i>Alu gold</i>	11.11742
<b>Alu bronze</b> <i>Alu bronze</i>	11.11744

**Art.nr. SB**  
No. DIY

10 x 90cm
11.12400
11.12402
11.12404

## Treppenkantenprofil 8,2mm für Laminat Stair Nosing 8,2mm for laminate

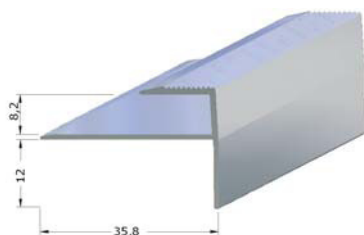

	10 x 270cm
<b>Alu silber</b> <i>Alu silver</i>	11.11750
<b>Alu gold</b> <i>Alu gold</i>	11.11752
<b>Alu bronze</b> <i>Alu bronze</i>	11.11754

**Art.nr.**  
No.

**Art.nr. SB**  
No. DIY

10 x 90cm
11.12410
11.12412
11.12414

## Treppenkantenprofil 13,2mm für Laminat und Parkett Stair Nosing 13,2mm for laminate and parquet

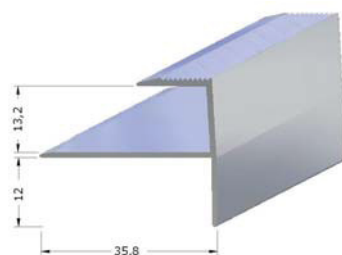

	10 x 270cm
<b>Alu silber</b> <i>Alu silver</i>	11.11780
<b>Alu gold</b> <i>Alu gold</i>	11.11782
<b>Alu bronze</b> <i>Alu bronze</i>	11.11784

**Art.nr.**  
No.

## Treppenkantenprofil 15,2mm für Laminat und Parkett Stair Nosing 15,2mm for laminate and parquet

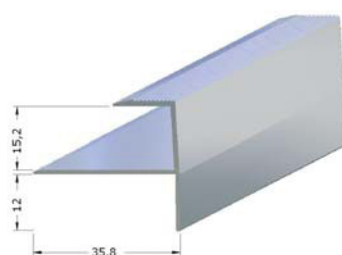

	10 x 270cm
<b>Alu silber</b> <i>Alu silver</i>	11.11800
<b>Alu gold</b> <i>Alu gold</i>	11.11802
<b>Alu bronze</b> <i>Alu bronze</i>	11.11804

**Art.nr.**  
No.





## Parkettssystem Roll – „professionell“ zum Schrauben Parquet system Roll – “professional” for screwing

Hochwertiges und universelles Profilsystem zum Schrauben für alle Hartbeläge bis 16mm (bzw. bis 22mm) Höhe. Sehr variabel durch die individuelle Kombination der Basisprofile in den Höhen: 6, 9 und 12 mm und der verschiedenen Deckelprofilen: Übergangsdehnfugenprofil, Abschlussprofil und Ausgleichprofil. Jeweils im Set bestehend aus Basisprofil Aluminium natur, gebohrt und gesenkt inklusive Schrauben und Dübel zur Befestigung am Untergrund sowie Deckelprofil Aluminium eloxiert, gebohrt und gesenkt, inklusive Befestigungsschrauben 9,5mm (Standard) bis 16mm Parkett oder Befestigungsschrauben 13mm (auf Anfrage) für Parkett bis 22mm Höhe. Länge 270cm oder 90cm in SB-Verpackung, jeweils im Set geschrumpft: Basisprofil + Deckelprofil + Schrauben und Dübel. Deutsches Gebrauchsmuster, Nr. 29711389.5.

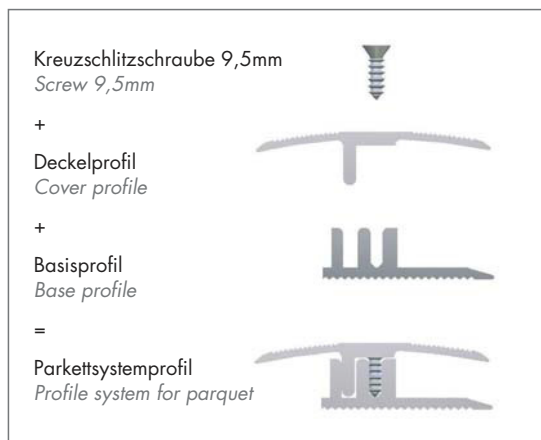
Premium and all-purpose profile system for screwing, for hard floor coverings up to 16mm (up to 22mm). Individual use due to the combination of base profiles available in 3 heights: 6, 9 and 12mm and cover profiles, which can be exchanged easily: expansion joint profile, edge trim and adapting profile. Set consists of one of the base profiles made of aluminium nature, drilled and countersunk, as well as one of the cover profiles made of aluminium anodized, drilled and countersunk, Set includes also screws and dowels; 9,5mm standard screw for parquet up to 16mm, or 13mm screw (upon request) for parquet up to 22mm. Length 270cm or 90cm in DIY package, both as a set, shrink-wrapped: base profile + cover profile + screws and dowels. German patent, no. 29711389.5.

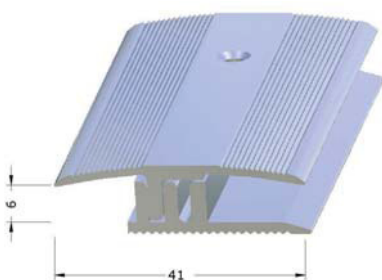

## Übergangsdehnfugenprofil mit 6mm Basisprofil Expansion joint profile with 6mm base profile



Art.nr.  
No.

Art.nr. SB  
No. DIY

Set 5 x 270cm

Set 5 x 90cm

Alu silber <i>Alu silver</i>	11.14100
Alu gold <i>Alu gold</i>	11.14105
Alu bronze <i>Alu bronze</i>	11.14110
Alu edelstahl <i>Alu stainless steel</i>	11.14115

11.22000
11.22002
11.22004
11.22006

## Übergangsdehnfugenprofil mit 9mm Basisprofil Expansion joint profile with 9mm base profile

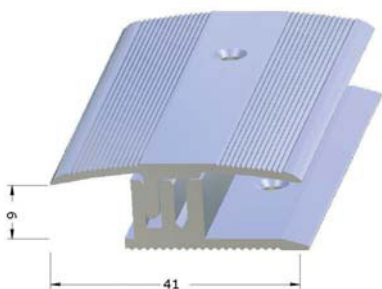

Art.nr.  
No.

Art.nr. SB  
No. DIY

Set 5 x 270cm

Set 5 x 90cm

Alu silber <i>Alu silver</i>	11.14120
Alu gold <i>Alu gold</i>	11.14125
Alu bronze <i>Alu bronze</i>	11.14130
Alu edelstahl <i>Alu stainless steel</i>	11.14135

11.22010
11.22012
11.22014
11.22016

## Übergangsdehnfugenprofil mit 12mm Basisprofil Expansion joint profile with 12mm base profile

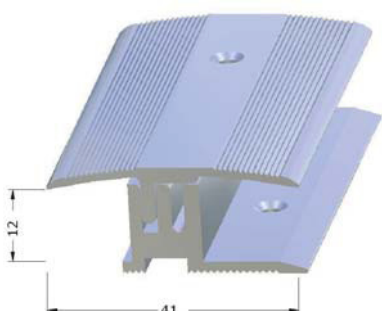

Art.nr.  
No.

Art.nr. SB  
No. DIY

Set 5 x 270cm

Set 5 x 90cm

Alu silber <i>Alu silver</i>	11.14140
Alu gold <i>Alu gold</i>	11.14145
Alu bronze <i>Alu bronze</i>	11.14150
Alu edelstahl <i>Alu stainless steel</i>	11.14155

11.22020
11.22022
11.22024
11.22026

Verpackungseinheit: 5 Stangen; SB-Verpackung inkl. Schrauben und Dübel, geschrumpft  
Packing unit: 5 bars; DIY packing: screws and dowels included, shrink wrapped

## Parkettssystem Roll – „professionell“ zum Schrauben Parquet system Roll – “professional” for screwing

Hochwertiges und universelles Profilsystem zum Schrauben für alle Hartbeläge bis 16mm (bzw. bis 22mm) Höhe. Sehr variabel durch die individuelle Kombination der Basisprofile in den Höhen: 6, 9 und 12 mm und der verschiedenen Deckelprofilen: Übergangsdehnfugenprofil, Abschlussprofil und Ausgleichprofil. Jeweils im Set bestehend aus Basisprofil Aluminium natur, gebohrt und gesenkt inklusive Schrauben und Dübel zur Befestigung am Untergrund sowie Deckelprofil Aluminium eloxiert, gebohrt und gesenkt, inklusive Befestigungsschrauben 9,5mm (Standard) bis 16mm Parkett oder Befestigungsschrauben 13mm (auf Anfrage) für Parkett bis 22mm Höhe. Länge 270cm oder 90cm in SB-Verpackung, jeweils im Set geschrumpft: Basisprofil + Deckelprofil + Schrauben und Dübel. Deutsches Gebrauchsmuster, Nr. 29711389.5.

Premium and all-purpose profile system for screwing, for hard floor coverings up to 16mm (up to 22mm). Individual use due to the combination of base profiles available in 3 heights: 6, 9 and 12mm and cover profiles, which can be exchanged easily: expansion joint profile, edge trim and adapting profile. Set consists of one of the base profiles made of aluminium nature, drilled and countersunk, as well as one of the cover profiles made of aluminium anodized, drilled and countersunk, Set includes also screws and dowels; 9,5mm standard screw for parquet up to 16mm, or 13mm screw (upon request) for parquet up to 22mm. Length 270cm or 90cm in DIY package, both as a set, shrink-wrapped: base profile + cover profile + screws and dowels. German patent, no. 29711389.5.

Kreuzschlitzschraube 9,5mm  
Screw 9,5mm



+

Deckelprofil  
Cover profile



+

Basisprofil  
Base profile



=

Parkettssystemprofil  
Profile system for parquet



### Abschlussprofil mit 6mm Basisprofil Edge Trim with 6mm base profile

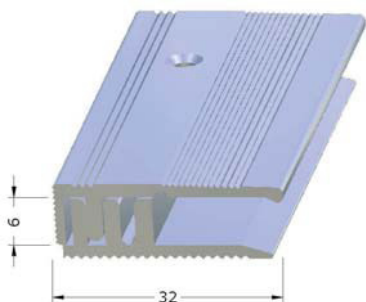

Art.nr.  
No.

Art.nr. SB  
No. DIY

Set 5 x 270cm

Set 5 x 90cm

Alu silber <i>Alu silver</i>	11.14160
Alu gold <i>Alu gold</i>	11.14165
Alu bronze <i>Alu bronze</i>	11.14170
Alu edelstahl <i>Alu stainless steel</i>	11.14175

11.22030
11.22032
11.22034
11.22036

### Abschlussprofil mit 9mm Basisprofil Edge Trim with 9mm base profile

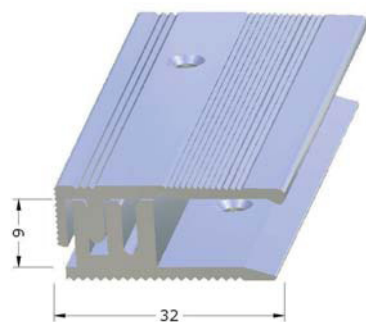

Art.nr.  
No.

Art.nr. SB  
No. DIY

Set 5 x 270cm

Set 5 x 90cm

Alu silber <i>Alu silver</i>	11.14180
Alu gold <i>Alu gold</i>	11.14185
Alu bronze <i>Alu bronze</i>	11.14190
Alu edelstahl <i>Alu stainless steel</i>	11.14195

11.22040
11.22042
11.22044
11.22046

### Abschlussprofil mit 12mm Basisprofil Edge Trim with 12mm base profile

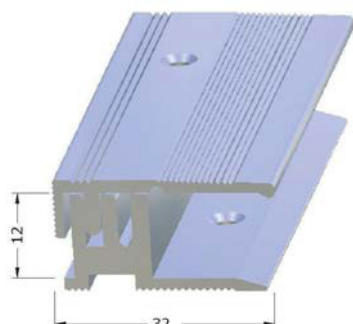

Art.nr.  
No.

Art.nr. SB  
No. DIY

Set 5 x 270cm

Set 5 x 90cm

Alu silber <i>Alu silver</i>	11.14200
Alu gold <i>Alu gold</i>	11.14205
Alu bronze <i>Alu bronze</i>	11.14210
Alu edelstahl <i>Alu stainless steel</i>	11.14215

11.22050
11.22052
11.22054
11.22056

Verpackungseinheit: 5 Stangen; SB-Verpackung inkl. Schrauben und Dübel, geschrumpft  
Packing unit: 5 bars; DIY packing: screws and dowels included, shrink wrapped

## Parkettssystem Roll – „professionell“ zum Schrauben Parquet system Roll – “professional” for screwing

Hochwertiges und universelles Profilsystem zum Schrauben für alle Hartbeläge bis 16mm (bzw. bis 22mm) Höhe. Sehr variabel durch die individuelle Kombination der Basisprofile in den Höhen: 6, 9 und 12 mm und der verschiedenen Deckelprofilen: Übergangsdehnfugenprofil, Abschlussprofil und Ausgleichsprofil. Jeweils im Set bestehend aus Basisprofil Aluminium natur, gebohrt und gesenkt inklusive Schrauben und Dübel zur Befestigung am Untergrund sowie Deckelprofil Aluminium eloxiert, gebohrt und gesenkt, inklusive Befestigungsschrauben 9,5mm (Standard) bis 16mm Parkett oder Befestigungsschrauben 13mm (auf Anfrage) für Parkett bis 22mm Höhe. Länge 270cm oder 90cm in SB-Verpackung, jeweils im Set geschrumpft: Basisprofil + Deckelprofil + Schrauben und Dübel. Deutsches Gebrauchsmuster, Nr. 29711389.5.

Premium and all-purpose profile system for screwing, for hard floor coverings up to 16mm (up to 22mm). Individual use due to the combination of base profiles available in 3 heights: 6, 9 and 12mm and cover profiles, which can be exchanged easily: expansion joint profile, edge trim and adapting profile. Set consists of one of the base profiles made of aluminium nature, drilled and countersunk, as well as one of the cover profiles made of aluminium anodized, drilled and countersunk, Set includes also screws and dowels; 9,5mm standard screw for parquet up to 16mm, or 13mm screw (upon request) for parquet up to 22mm. Length 270cm or 90cm in DIY package, both as a set, shrink-wrapped: base profile + cover profile + screws and dowels. German patent, no. 29711389.5.

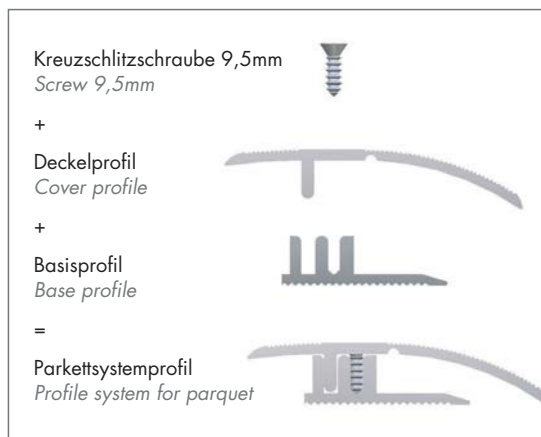

## Ausgleichsprofil mit 6mm Basisprofil Adapting Profile with 6mm base profile

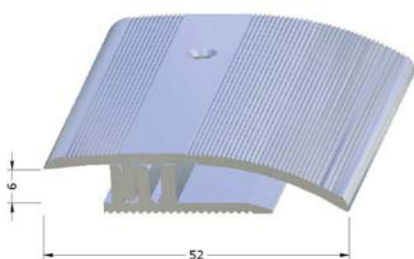

**Art.nr.**  
No.

**Art.nr. SB**  
No. DIY

**Set 5 x 270cm**

**Set 5 x 90cm**

<b>Alu silber</b> <i>Alu silver</i>	11.14220
<b>Alu gold</b> <i>Alu gold</i>	11.14225
<b>Alu bronze</b> <i>Alu bronze</i>	11.14230
<b>Alu edelstahl</b> <i>Alu stainless steel</i>	11.14235

11.22060
11.22062
11.22064
11.22066

## Ausgleichsprofil mit 9mm Basisprofil Adapting Profile with 9mm base profile

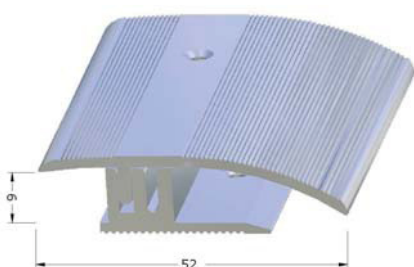

**Art.nr.**  
No.

**Art.nr. SB**  
No. DIY

**Set 5 x 270cm**

**Set 5 x 90cm**

<b>Alu silber</b> <i>Alu silver</i>	11.14240
<b>Alu gold</b> <i>Alu gold</i>	11.14245
<b>Alu bronze</b> <i>Alu bronze</i>	11.14250
<b>Alu edelstahl</b> <i>Alu stainless steel</i>	11.14255

11.22070
11.22072
11.22074
11.22076

## Ausgleichsprofil mit 12mm Basisprofil Adapting Profile with 12mm base profile

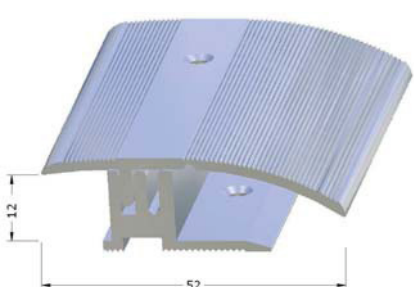

**Art.nr.**  
No.

**Art.nr. SB**  
No. DIY

**Set 5 x 270cm**

**Set 5 x 90cm**

<b>Alu silber</b> <i>Alu silver</i>	11.14260
<b>Alu gold</b> <i>Alu gold</i>	11.14265
<b>Alu bronze</b> <i>Alu bronze</i>	11.14270
<b>Alu edelstahl</b> <i>Alu stainless steel</i>	11.14275

11.22080
11.22082
11.22084
11.22086

## Parkettssystem Roll – „light“ zum Schrauben Parquet system Roll – „light“ for screwing

Unser bewährtes Parkettssystem jetzt auch in filigraner Form  
– nur 34mm breit

Our well-known parquet profile system in filigree shape  
– only 34mm wide

Jeweils im Set geschumpft: Basisprofil + Deckelprofil + Schrauben und Dübel.  
Set, shrink-wrapped: base profile + cover profile + screws and dowels

Kreuzschlitzschraube 9,5mm  
Screw 9,5mm



+  
Deckelprofil light  
Cover profile



+  
Basisprofil  
Base profile



=  
Parkettssystemprofil  
Profile system for parquet



## Übergangsdehnfugenprofil „light“ mit 6mm Basisprofil Expansion joint profile „light“ with 6mm base profile

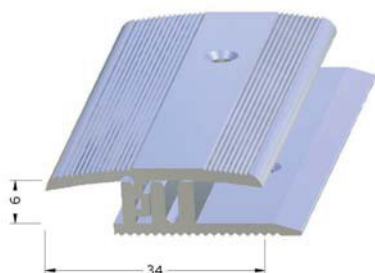

Art.nr.  
No.

Art.nr. SB  
No. DIY

Set 5 x 270cm

Set 5 x 90cm

Alu silber <i>Alu silver</i>	11.14400
Alu gold <i>Alu gold</i>	11.14402
Alu bronze <i>Alu bronze</i>	11.14404
Alu edelstahl <i>Alu stainless steel</i>	11.14406

11.22100
11.22102
11.22104
11.22106

## Übergangsdehnfugenprofil „light“ mit 9mm Basisprofil Expansion joint profile „light“ with 9mm base profile

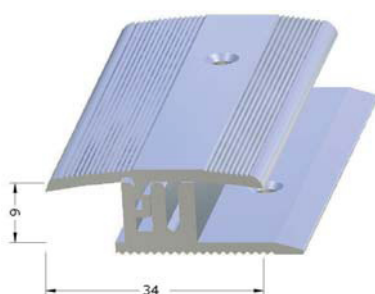

Art.nr.  
No.

Art.nr. SB  
No. DIY

Set 5 x 270cm

Set 5 x 90cm

Alu silber <i>Alu silver</i>	11.14410
Alu gold <i>Alu gold</i>	11.14412
Alu bronze <i>Alu bronze</i>	11.14414
Alu edelstahl <i>Alu stainless steel</i>	11.14416

11.22110
11.22112
11.22114
11.22116

## Übergangsdehnfugenprofil „light“ mit 12mm Basisprofil Expansion joint profile „light“ with 12mm base profile

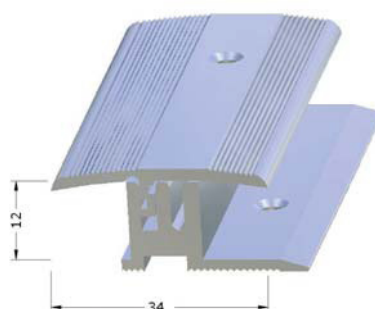

Art.nr.  
No.

Art.nr. SB  
No. DIY

Set 5 x 270cm

Set 5 x 90cm

Alu silber <i>Alu silver</i>	11.14420
Alu gold <i>Alu gold</i>	11.14422
Alu bronze <i>Alu bronze</i>	11.14424
Alu edelstahl <i>Alu stainless steel</i>	11.14426

11.22120
11.22122
11.22124
11.22126

## Parkettssystem Roll – „light“ zum Schrauben Parquet system Roll – „light“ for screwing

Unser bewährtes Parkettssystem jetzt auch in filigraner Form  
– nur 22,5mm breit

Our well-known parquet profile system in filigree shape  
– only 22,5mm wide

Jeweils im Set geschumpft: Basisprofil + Deckelprofil + Schrauben und Dübel.  
Set, shrink-wrapped: base profile + cover profile + screws and dowels

Kreuzschlitzschraube 9,5mm  
Screw 9,5mm



+  
Deckelprofil  
Cover profile



+  
Basisprofil  
Base profile



=  
Parkettssystemprofil  
Profile system for parquet



## Abschlussprofil „light“ mit 6mm Basisprofil Edge Trim „light“ with 6mm base profile

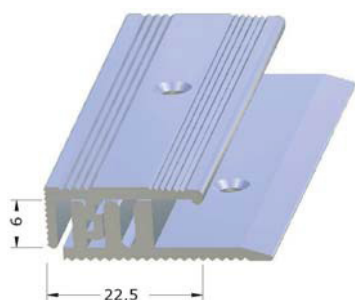

Art.nr.  
No.

Art.nr. SB  
No. DIY

Set 5 x 270cm

Set 5 x 90cm

Alu silber <i>Alu silver</i>	11.14430
Alu gold <i>Alu gold</i>	11.14432
Alu bronze <i>Alu bronze</i>	11.14434
Alu edelstahl <i>Alu stainless steel</i>	11.14436

11.22130
11.22132
11.22134
11.22136

## Abschlussprofil „light“ mit 9mm Basisprofil Edge Trim „light“ with 9mm base profile

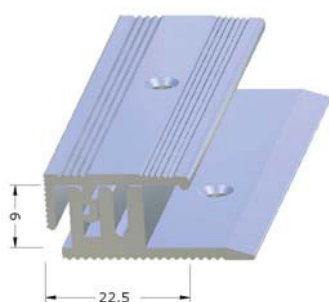

Art.nr.  
No.

Art.nr. SB  
No. DIY

Set 5 x 270cm

Set 5 x 90cm

Alu silber <i>Alu silver</i>	11.14440
Alu gold <i>Alu gold</i>	11.14442
Alu bronze <i>Alu bronze</i>	11.14444
Alu edelstahl <i>Alu stainless steel</i>	11.14446

11.22140
11.22142
11.22144
11.22146

## Abschlussprofil „light“ mit 12mm Basisprofil Edge Trim „light“ with 12mm base profile

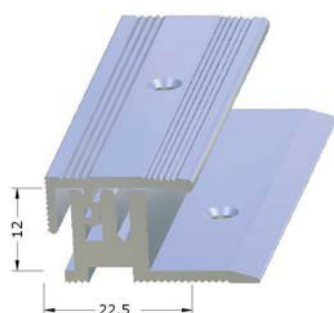

Art.nr.  
No.

Art.nr. SB  
No. DIY

Set 5 x 270cm

Set 5 x 90cm

Alu silber <i>Alu silver</i>	11.14450
Alu gold <i>Alu gold</i>	11.14452
Alu bronze <i>Alu bronze</i>	11.14454
Alu edelstahl <i>Alu stainless steel</i>	11.14456

11.22150
11.22152
11.22154
11.22156



## Parkettssystem Roll – „light“ zum Schrauben Parquet system Roll – „light“ for screwing

Unser bewährtes Parkettssystem jetzt auch in filigraner Form  
– nur 44mm breit

Our well-known parquet profile system in filigree shape  
– only 44mm wide

Jeweils im Set geschumpft: Basisprofil + Deckelprofil + Schrauben und Dübel.  
Set, shrink-wrapped: base profile + cover profile + screws and dowels

Kreuzschlitzschraube 9,5mm  
Screw 9,5mm



+  
Deckelprofil light  
Cover profile



+  
Basisprofil  
Base profile



=  
Parkettssystemprofil  
Profile system for parquet



## Ausgleichsprofil „light“ mit 6mm Basisprofil Adapting profile „light“ with 6mm base profile

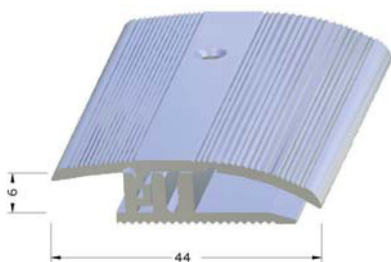

Art.nr.  
No.

Art.nr. SB  
No. DIY

Set 5 x 270cm

Set 5 x 90cm

Alu silber <i>Alu silver</i>	11.14460
Alu gold <i>Alu gold</i>	11.14462
Alu bronze <i>Alu bronze</i>	11.14464
Alu edelstahl <i>Alu stainless steel</i>	11.14466

11.22160
11.22162
11.22164
11.22166

## Ausgleichsprofil „light“ mit 9mm Basisprofil Adapting profile „light“ with 9mm base profile

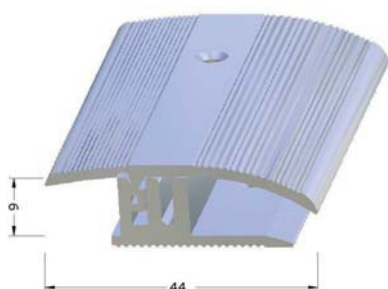

Art.nr.  
No.

Art.nr. SB  
No. DIY

Set 5 x 270cm

Set 5 x 90cm

Alu silber <i>Alu silver</i>	11.14470
Alu gold <i>Alu gold</i>	11.14472
Alu bronze <i>Alu bronze</i>	11.14474
Alu edelstahl <i>Alu stainless steel</i>	11.14476

11.22170
11.22172
11.22174
11.22176

## Ausgleichsprofil „light“ mit 12mm Basisprofil Adapting profile „light“ with 12mm base profile

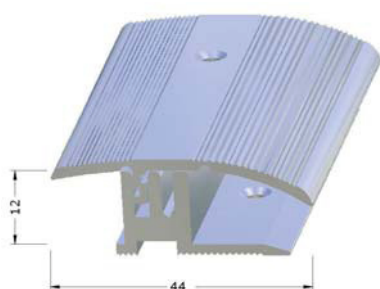

Art.nr.  
No.

Art.nr. SB  
No. DIY

Set 5 x 270cm

Set 5 x 90cm

Alu silber <i>Alu silver</i>	11.14480
Alu gold <i>Alu gold</i>	11.14482
Alu bronze <i>Alu bronze</i>	11.14484
Alu edelstahl <i>Alu stainless steel</i>	11.14486

11.22180
11.22182
11.22184
11.22186

## Laminatsystem Roll „light“ zum Clipsen – auch mit Holzdekor

Laminate system Roll „light“ with clips – also with wooden veneers available

Hochwertiges und universelles Profilesystem in filigraner Form zum Clipsen für alle Hartbeläge bis 16mm Höhe (bzw. bis 22mm mit Zusatzclip). Sehr variabel durch die individuelle Kombination von Basisprofilen in 2 Höhen: 7 und 14 mm und 3 verschiedenen Deckelprofilen die bei Bedarf gegeneinander ausgetauscht werden können: Übergangsfugenprofil, Abschlussprofil und Ausgleichprofil. Set besteht aus einem Basisprofil aus Aluminium natur, gebohrt und gesenkt inklusive Schrauben und Dübel zur Befestigung am Untergrund sowie einem Deckelprofil aus Aluminium eloxiert bzw. mit dekorativem Holzdekor inklusive Clip. Länge 270cm oder 90cm in SB-Verpackung, jeweils im Set geschrumpft: Basisprofil + Deckelprofil + 50cm Clipsleiste + Schrauben und Dübel.

Premium and all-purpose profile system in filigree shape, for hard floor coverings up to 16mm (up to 22mm with additional clip). Fixing with clips. Individual use due to the combination of base profiles available in 2 heights: 7 and 14mm and cover profiles, which can be exchanged easily: expansion joint profile, edge trim and adapting profile. Set consists of one of the base profiles made of aluminium nature, drilled and countersunk, as well as one of the cover profiles made of aluminium anodized respectively with wooden effect, clips included. Length 270cm or 90cm in DIY package, both as a set, shrink-wrapped: base profile + cover profile + 50cm clip profile + screws and dowels

Deckelprofil „light“  
Cover profile „light“

+

Clip clip

+

Basisprofil  
Base profile

=

Parkettsystemprofil  
Profile system for parquet

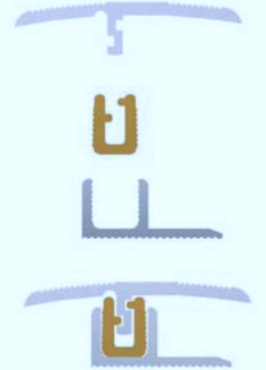

## Übergangsfugenprofil „light“ mit 7mm Basisprofil

Expansion joint profile „light“ with 7mm base profile

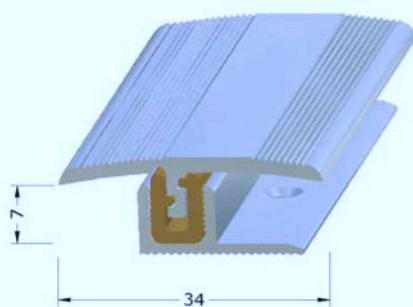

mit Holzdekor  
with wooden veneers

Art.nr.  
No.

Art.nr. SB  
No. DIY

Set 5 x 270cm

Set 5 x 90cm

<b>Alu silber</b> <i>Alu silver</i>	11.16000	11.12800
<b>Alu gold</b> <i>Alu gold</i>	11.16005	11.12802
<b>Alu edelstahl</b> <i>Alu stainless steel</i>	11.16006	11.12801
<b>Buche</b> <i>Beach</i>	11.16010	11.12804
<b>Ahorn</b> <i>Maple</i>	11.16015	11.12805
<b>Eiche</b> <i>Oak</i>	11.16020	11.12803
<b>Kirsche</b> <i>Cherry</i>	11.16025	11.12806

## Übergangsfugenprofil „light“ mit 14mm Basisprofil

Expansion joint profile „light“ with 14mm base profile

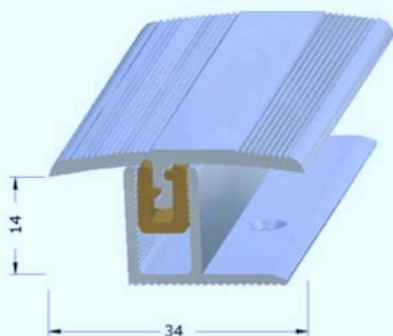

mit Holzdekor  
with wooden veneers

Art.nr.  
No.

Art.nr. SB  
No. DIY

Set 5 x 270cm

Set 5 x 90cm

<b>Alu silber</b> <i>Alu silver</i>	11.16030	11.12900
<b>Alu gold</b> <i>Alu gold</i>	11.16036	11.12901
<b>Alu edelstahl</b> <i>Alu stainless steel</i>	11.16035	11.12902
<b>Buche</b> <i>Beach</i>	11.16040	11.12904
<b>Ahorn</b> <i>Maple</i>	11.16045	11.12905
<b>Eiche</b> <i>Oak</i>	11.16050	11.12903
<b>Kirsche</b> <i>Cherry</i>	11.16055	11.12906

## Laminatsystem Roll „light“ zum Clipsen – auch mit Holzdekor

Laminate system Roll „light“ with clips – also with wooden veneers available

Hochwertiges und universelles Profilsystem in filigraner Form zum Clipsen für alle Hartbeläge bis 16mm Höhe (bzw. bis 22mm mit Zusatzclip). Sehr variabel durch die individuelle Kombination von Basisprofilen und Deckelprofilen: Übergangsdehnfugenprofil, Abschlussprofil und Ausgleichsprofil. Länge 270cm oder 90cm in SB-Verpackung, jeweils im Set geschumpft: Basisprofil + Deckelprofil + 50cm Clipsleiste + Schrauben und Dübel.

Premium and all-purpose profile system in filigree shape, for hard floor coverings up to 16mm (up to 22mm with additional clip). Fixing with clips. Individual use due to the combination of base profiles and cover profiles: expansion joint profile, edge trim and adapting profile. Length 270cm or 90cm in DIY package, both as set, shrink-wrapped: base profile + cover profile + 50cm clip profile + screws and dowels.

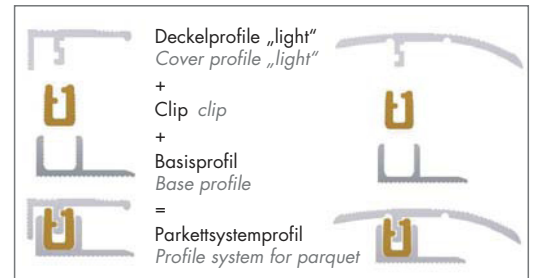

## Abschlussprofil „light“ mit 7mm Basisprofil

Edge Trim „light“ with 7mm base profile

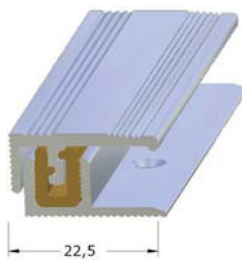

mit Holzdekor  
with wooden veneers

	Art.nr. No.	Art.nr. SB No. DIY
	<b>Set 5 x 270cm</b>	<b>Set 5 x 90cm</b>
<b>Alu silber</b> <i>Alu silver</i>	11.16060	11.12810
<b>Alu gold</b> <i>Alu gold</i>	11.16065	11.12812
<b>Alu edelstahl</b> <i>Alu stainless steel</i>	11.16066	11.12811
<b>Buche</b> <i>Beach</i>	11.16070	11.12814
<b>Ahorn</b> <i>Maple</i>	11.16075	11.12815
<b>Eiche</b> <i>Oak</i>	11.16080	11.12813
<b>Kirsche</b> <i>Cherry</i>	11.16085	11.12816

## Abschlussprofil „light“ mit 14mm Basisprofil

Edge Trim „light“ with 14mm base profile

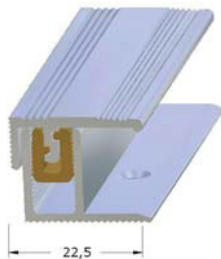

mit Holzdekor  
with wooden veneers

	Art.nr. No.	Art.nr. SB No. DIY
	<b>Set 5 x 270cm</b>	<b>Set 5 x 90cm</b>
<b>Alu silber</b> <i>Alu silver</i>	11.16090	11.12910
<b>Alu gold</b> <i>Alu gold</i>	11.16095	11.12912
<b>Alu edelstahl</b> <i>Alu stainless steel</i>	11.16096	11.12911
<b>Buche</b> <i>Beach</i>	11.16100	11.12914
<b>Ahorn</b> <i>Maple</i>	11.16105	11.12915
<b>Eiche</b> <i>Oak</i>	11.16110	11.12913
<b>Kirsche</b> <i>Cherry</i>	11.16115	11.12916

## Ausgleichsprofil „light“ mit 7mm Basisprofil

Adapting profile „light“ with 7mm base profile

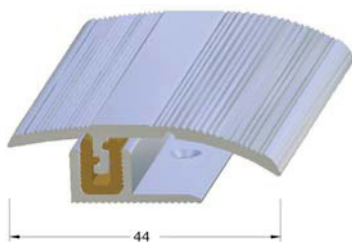

mit Holzdekor  
with wooden veneers

	Art.nr. No.	Art.nr. SB No. DIY
	<b>Set 5 x 270cm</b>	<b>Set 5 x 90cm</b>
<b>Alu silber</b> <i>Alu silver</i>	11.16120	11.12820
<b>Alu gold</b> <i>Alu gold</i>	11.16125	11.12822
<b>Alu edelstahl</b> <i>Alu stainless steel</i>	11.16126	11.12821
<b>Buche</b> <i>Beach</i>	11.16130	11.12824
<b>Ahorn</b> <i>Maple</i>	11.16135	11.12825
<b>Eiche</b> <i>Oak</i>	11.16140	11.12823
<b>Kirsche</b> <i>Cherry</i>	11.16145	11.12826

## Ausgleichsprofil „light“ mit 14mm Basisprofil

Adapting profile „light“ with 14mm base profile

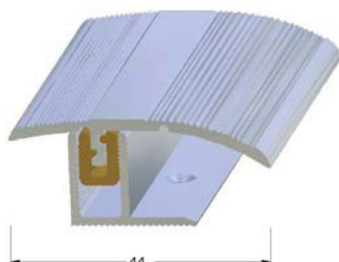

mit Holzdekor  
with wooden veneers

	Art.nr. No.	Art.nr. SB No. DIY
	<b>Set 5 x 270cm</b>	<b>Set 5 x 90cm</b>
<b>Alu silber</b> <i>Alu silver</i>	11.16150	11.12920
<b>Alu gold</b> <i>Alu gold</i>	11.16155	11.12922
<b>Alu edelstahl</b> <i>Alu stainless steel</i>	11.16156	11.12921
<b>Buche</b> <i>Beach</i>	11.16160	11.12924
<b>Ahorn</b> <i>Maple</i>	11.16165	11.12925
<b>Eiche</b> <i>Oak</i>	11.16170	11.12923
<b>Kirsche</b> <i>Cherry</i>	11.16175	11.12926



Winkelprofile

*Angle Edges*



## Winkelprofil 10x24,5mm Angle Edge 10x24,5mm

Universell einsetzbarer Winkel, auf Null auslaufend. Mit Zierrillen. Robustes Profil 2,0mm dick. Gebohrt und gesenkt. Länge 270cm oder 90cm in SB-Verpackung. *All-purpose angle edge, ends to zero, fluted. Robust profile 2,0mm thick. Drilled and countersunk. Length 270cm or 90cm in DIY-package.*

**Art.nr.**  
No.

**Art.nr. SB**  
No. DIY

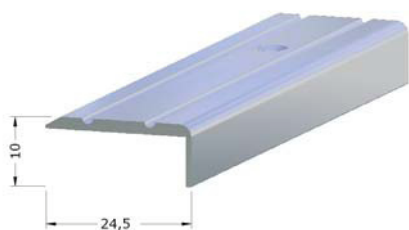

**10 x 270cm**

**10 x 90cm**

<b>Alu silber</b> <i>Alu silver</i>	11.10620
<b>Alu gold</b> <i>Alu gold</i>	11.10630
<b>Alu bronze</b> <i>Alu bronze</i>	11.10640
<b>Alu edelstahl</b> <i>Alu stainless steel</i>	11.10644

11.12230
11.12232
11.12234
11.12224

## Winkelprofil 10x24,5mm ungebohrt Angle Edge 10x24,5mm undrilled

Ungebohrt, Befestigung z.B. mit Montagekleber Art.nr. 18.12985  
*Undrilled, assembly with adhesive no. 18.12985*

**Art.nr.**  
No.

**Art.nr. SB**  
No. DIY



**10 x 270cm**

**10 x 90cm**

<b>Alu silber</b> <i>Alu silver</i>	11.10622
<b>Alu gold</b> <i>Alu gold</i>	11.10632
<b>Alu bronze</b> <i>Alu bronze</i>	11.10642
<b>Alu edelstahl</b> <i>Alu stainless steel</i>	11.10645
<b>Buche</b> <i>Beach</i>	11.17240
<b>Ahorn</b> <i>Maple</i>	11.17241
<b>Eiche</b> <i>Oak</i>	11.17242
<b>Kirsche</b> <i>Cherry</i>	11.17243

11.12231
11.12233
11.12235
11.12200
11.12202
11.12204
11.12206

## Winkelprofil 10x24,5mm selbstklebend Angle Edge 10x24,5mm self-adhesive

Selbstklebend, mit 2 hochwertigen, transparenten Kleberschnüren.  
*Self-adhesive, with 2 premium, transparent adhesive laces*

**Art.nr.**  
No.

**Art.nr. SB**  
No. DIY

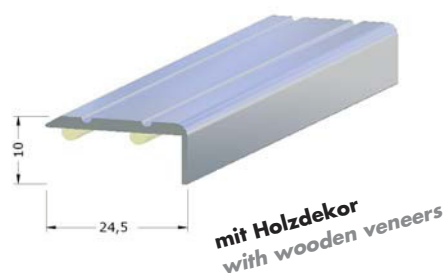

**10 x 270cm**

**10 x 90cm**

<b>Alu silber</b> <i>Alu silver</i>	11.10623
<b>Alu gold</b> <i>Alu gold</i>	11.10633
<b>Alu bronze</b> <i>Alu bronze</i>	11.10643
<b>Alu edelstahl</b> <i>Alu stainless steel</i>	11.10646
<b>Buche</b> <i>Beach</i>	11.17250
<b>Ahorn</b> <i>Maple</i>	11.17251
<b>Eiche</b> <i>Oak</i>	11.17252
<b>Kirsche</b> <i>Cherry</i>	11.17253

11.12237
11.12238
11.12239
11.12226
11.22208
11.22210
11.22212
11.22214



## Winkelprofil 20x24,5mm Angle Edge 20x24,5mm

Universell einsetzbarer Winkel, auf Null auslaufend. Mit Zierrillen. Robustes Profil 2,0mm dick. Gebohrt und gesenkt. Länge 270cm oder 90cm in SB-Verpackung. *All-purpose angle edge, ends to zero, fluted. Solid profile 2,0mm thick. Drilled and countersunk. Length 270cm or 90cm in DIY-package*

**Art.nr.**  
No.

**Art.nr. SB**  
No. DIY

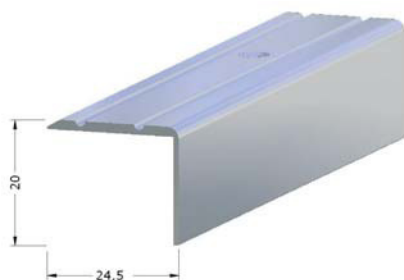

**10 x 270cm**

**10 x 90cm**

<b>Alu silber</b> <i>Alu silver</i>	11.10650
<b>Alu gold</b> <i>Alu gold</i>	11.10660
<b>Alu bronze</b> <i>Alu bronze</i>	11.10670
<b>Alu edelstahl</b> <i>Alu stainless steel</i>	11.10674

11.12240
11.12242
11.12244
11.12227

## Winkelprofil 20x24,5mm ungebohrt Angle Edge 20x24,5mm undrilled

Ungebohrt, Befestigung z.B. mit Montagekleber Art.nr. 18.12985  
*Undrilled, assembly with adhesive no. 18.12985*

**Art.nr.**  
No.

**Art.nr. SB**  
No. DIY

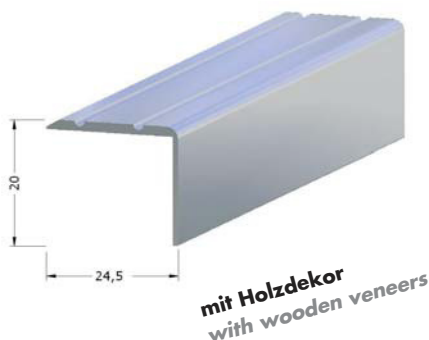

**10 x 270cm**

**10 x 90cm**

<b>Alu silber</b> <i>Alu silver</i>	11.10652
<b>Alu gold</b> <i>Alu gold</i>	11.10662
<b>Alu bronze</b> <i>Alu bronze</i>	11.10672
<b>Alu edelstahl</b> <i>Alu stainless steel</i>	11.10675
<b>Buche</b> <i>Beach</i>	11.17260
<b>Ahorn</b> <i>Maple</i>	11.17261
<b>Eiche</b> <i>Oak</i>	11.17262
<b>Kirsche</b> <i>Cherry</i>	11.17263

11.12241
11.12243
11.12245
11.12228
11.22216
11.22218
11.22220
11.22222

## Winkelprofil 20x24,5mm selbstklebend Angle Edge 20x24,5mm self-adhesive

Selbstklebend, mit 2 hochwertigen, transparenten Kleberschnüren.  
*Self-adhesive, with 2 premium, transparent adhesive laces*

**Art.nr.**  
No.

**Art.nr. SB**  
No. DIY

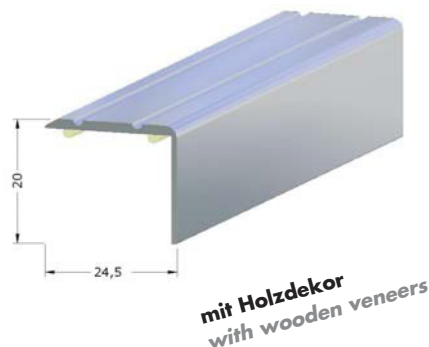

**10 x 270cm**

**10 x 90cm**

<b>Alu silber</b> <i>Alu silver</i>	11.10653
<b>Alu gold</b> <i>Alu gold</i>	11.10663
<b>Alu bronze</b> <i>Alu bronze</i>	11.10673
<b>Alu edelstahl</b> <i>Alu stainless steel</i>	11.10676
<b>Buche</b> <i>Beach</i>	11.17270
<b>Ahorn</b> <i>Maple</i>	11.17271
<b>Eiche</b> <i>Oak</i>	11.17272
<b>Kirsche</b> <i>Cherry</i>	11.17273

11.12247
11.12248
11.12249
11.12229
11.22224
11.22226
11.22228
11.22230

## Winkelprofil 20x20mm, geriffelt Angle Edge 20x20mm, fluted

Universell einsetzbarer Messingwinkel, auf Null auslaufend, geriffelt. Gebohrt und gesenkt. Aus hochwertigem Messing poliert. Länge 270cm oder 90cm in SB-Verpackung. *All-purpose angle edge made of premium polished brass, ends to zero, fluted. Drilled and countersunk. Length 270cm or 90cm in DIY-package.*

**Art.nr.**  
No.

**Art.nr. SB**  
No. DIY

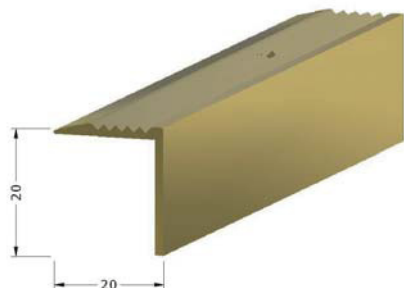

**10 x 270cm**

**10 x 90cm**

**Messing poliert** *Brass polished*

11.10600

11.12282

## Winkelprofil 30x30mm, geriffelt Angle Edge 30x30mm, fluted

Universell einsetzbarer Messingwinkel, auf Null auslaufend, geriffelt. Gebohrt und gesenkt. Aus hochwertigem Messing poliert. Länge 270cm oder 90cm in SB-Verpackung. *All-purpose angle edge made of premium polished brass, ends to zero, fluted. Drilled and countersunk. Length 270cm or 90cm in DIY-package.*

**Art.nr.**  
No.

**Art.nr. SB**  
No. DIY

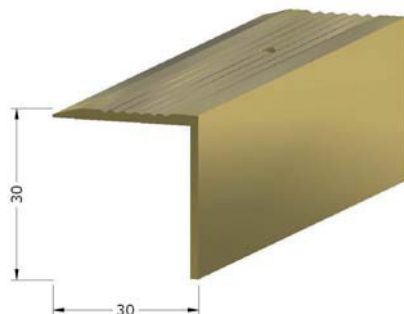

**10 x 270cm**

**10 x 90cm**

**Messing poliert** *Brass polished*

11.10610

11.12196

## Kantenschutzprofil 25x25mm selbstklebend Angle Edge 25x25mm self-adhesive

Universell einsetzbares Kantenschutzprofil mit abgerundeten Außenkanten. Robustes Profil 1,5mm dick. Selbstklebend. Länge 300cm oder 100cm in SB-Verpackung. *All-purpose angle edge, with rounded edges. Robust profile 1,5mm thick. Self-adhesive. Length 300cm or 100cm in DIY-package.*

**Art.nr.**  
No.

**Art.nr. SB**  
No. DIY

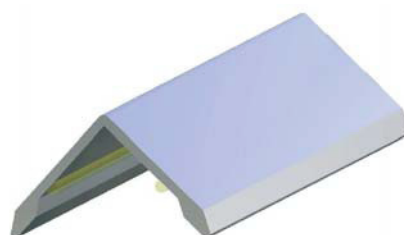

**10 x 300cm**

**10 x 100cm**

**Alu silber** *Alu silver*

11.10677

11.12260

**Alu gold** *Alu gold*

11.10678

11.12262

**Alu edelstahl** *Alu stainless steel*

11.10679

11.12264

# Treppenkantenprofile

# Stair Nosing



## Treppenkantenprofil mit Leuchtkörper Stair Nosing with illumination

Treppenkantenprofil mit beleuchtetem Lichtkanal zur Verlegung in Kinos, Restaurant, Discotheken etc. Für ästhetisch anspruchsvolle Objekte und zur Unterstützung der Sicherheit bei gering beleuchteten Treppenstufen. Zur Verlegung auf Bodenbelägen. Das Treppenkantenprofil wird mit Montagekleber 18.12985 verlegt, auch eine nachträgliche Bohrung/Verschraubung ist möglich. In den Lichtkanal des Profils wird ein Polycarbonatprofil mit LED-Streifen eingeschoben und über einen Transformator angeschlossen. Durch die LED-Technik besonders energiesparend! Länge Alu Profil 600cm und Polycarbonat Profil 200cm. Länge LED-Streifen 40cm verbindbar, 12 Volt, 200 mA, 2,4 Watt (weiß und blau) bzw. 1,2 Watt (rot, gelb, grün). Transformator, Größe nach Absprache. *Illuminated stair nosing for laying in cinemas, restaurants, discos etc. Assembly on top of floor coverings. Assembly of stair nosing with adhesive no. 18.12985; can also be drilled and screwed afterwards. Polycarbonate profile together with LED strips is inserted in the aluminium profile and connected via transformer. Energy-saving due to LED technology. Length aluminium profile 600cm, Polycarbonate profile 200cm. Length LED-strips 40cm combinable, 12 Volt, 200 mA, 2,4 Watt (white and blue) respectively. 1,2 Watt (red, yellow, green). Transformer upon request.*

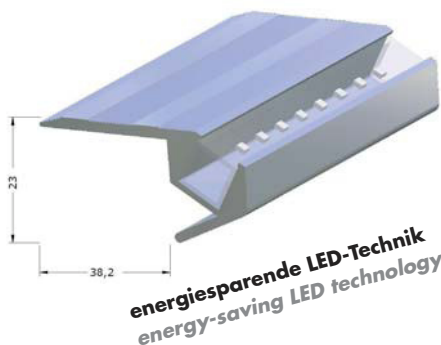

Art.nr.  
No.

Art.nr.  
No.

**5 x 600cm**

**Alu edelstahl** *Alu stainless steel*

11.10090

**Profil 10x10mm, 200 cm**

11.10092

**LED - Streifen 40cm weiß** *LED strip 40cm white*

11.10093 B

**LED - Streifen 40cm blau** *LED strip 40cm blue*

11.10094 B

**LED - Streifen 40cm rot** *LED strip 40cm red*

11.10095 B

**LED - Streifen 40cm gelb** *LED strip 40cm yellow*

11.10096 B

**LED - Streifen 40cm grün** *LED strip 40cm green*

11.10097 B

## Treppenkantenprofil 22x42mm Stair Nosing 22x42mm

Treppenkantenprofil zur universellen Verlegung auf allen Belägen, mit Antirutschrillen. Auf Null auslaufend. Gebohrt und gesenkt. Länge 300cm oder 100cm in SB-Verpackung. *All-purpose stair nosing, fluted, tapered, ends to zero. Drilled and countersunk. Length 300cm or 100cm in DIY-package.*

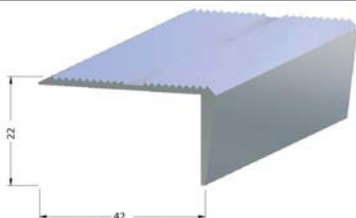

Art.nr.  
No.

Art.nr. SB  
No. DIY

**10 x 300cm**

**10 x 100cm**

**Alu silber** *Alu silver*

11.11040

11.12430

**Alu gold** *Alu gold*

11.11050

11.12432

**Alu bronze** *Alu bronze*

11.11060

11.12434

**Alu edelstahl** *Alu stainless steel*

11.11043

11.12431

## Treppenkantenprofil 22x42mm ungebohrt Stair Nosing 22x42mm undrilled

Ungebohrt, Befestigung mit PU-Montagekleber Art.nr. 18.12895  
*Undrilled, assembly with PU-adhesive no. 18.12895.*

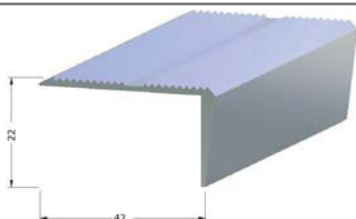

Art.nr.  
No.

Art.nr. SB  
No. DIY

**10 x 300cm**

**10 x 100cm**

**Alu silber** *Alu silver*

11.11042

11.12436

**Alu gold** *Alu gold*

11.11052

11.12438

**Alu bronze** *Alu bronze*

11.11062

11.12439

**Alu edelstahl** *Alu stainless steel*

11.11046

11.12437

**Alu natur** *Alu nature*

11.11044

11.12440

## Treppenkantenprofil 22x42mm selbstklebend Stair Nosing 22x42mm self-adhesive

Selbstklebend, mit 2 hochwertigen, transparenten Kleberschnüren.  
*Self-adhesive, with 3 premium, transparent adhesive laces.*

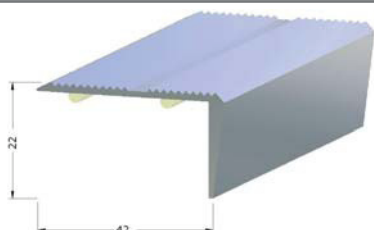

Art.nr.  
No.

Art.nr. SB  
No. DIY

**10 x 300cm**

**10 x 100cm**

**Alu silber** *Alu silver*

11.11041

11.12441

**Alu gold** *Alu gold*

11.11051

11.12442

**Alu bronze** *Alu bronze*

11.11061

11.12445

**Alu edelstahl** *Alu stainless steel*

11.11048

11.12444

**Alu natur** *Alu nature*

11.11047

11.12443

Verpackungseinheit: 10 Stangen; SB-Verpackung inkl. Schrauben und Dübel, geschrumpft  
*Packing unit: 10 bars; DIY packing: screws and dowels included, shrink wrapped*



## Treppenkantenprofil 2,6x12mm für Lino Stair Nosing 2,6x12mm for lino

Treppenprofil für Lino, PVC und Korkbeläge bis 2,6mm. Besonders filigraner Abschluss der Kante. Gebohrt und gesenkt. Länge 270cm. *Stair nosing for lino, PVC and cork up to 2,6mm. Drilled and countersunk. Length 270cm*

**Art.nr.**  
No.

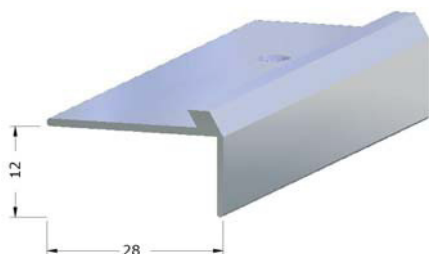

**Alu silber** *Alu silver*

**10 x 270cm**

11.11021

## Treppenkantenprofil 3,3x12mm für Lino Stair Nosing 3,3x16mm for lino

Treppenprofil für Lino, PVC und Korkbeläge bis 3,3mm. Besonders filigraner Abschluss der Kante. Gebohrt und gesenkt. Länge 270cm. *Stair nosing for lino, PVC and cork up to 3,3mm. Drilled and countersunk. Length 270cm.*

**Art.nr.**  
No.

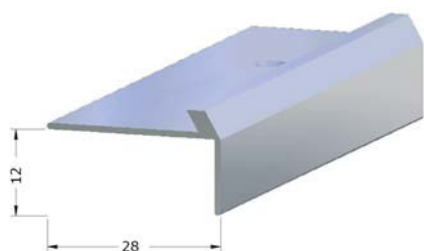

**Alu silber** *Alu silver*

**10 x 270cm**

**Alu gold** *Alu gold*

11.11024

11.11025

## Treppenkantenprofil 3x20mm für Lino Stair Nosing 3x20mm for lino

Treppenprofil für Lino, PVC und Korkbeläge bis 3mm. Besonders filigraner Abschluss der Kante. Gebohrt und gesenkt. Länge 300cm. *Stair nosing for lino, PVC and cork up to 3mm. Drilled and countersunk. Length 300cm.*

**Art.nr.**  
No.

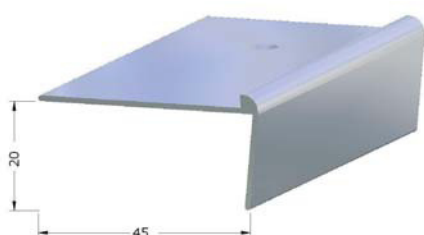

**Alu silber** *Alu silver*

**10 x 300cm**

**Alu gold** *Alu gold*

**Messing** *Brass*

11.11032

11.11033

11.11034

## Treppenkantenprofil 5x40mm Stair Nosing 5x40mm

Zur Verlegung von Belägen bis 5mm, mit Einschub. Zur Treppensanierung mit extra langer Nase. Gebohrt und gesenkt. Länge 300cm. *Stair nosing for floor coverings up to 5mm. For renovation of stairs, with extra long drop side. Drilled and countersunk. Length 300cm.*

**Art.nr.**  
No.

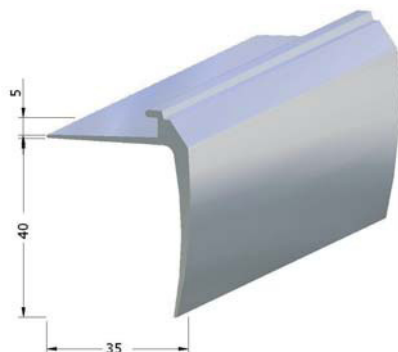

**Alu silber** *Alu silver*

**10 x 300cm**

**Alu gold** *Alu gold*

**Alu bronze** *Alu bronze*

11.11010

auf Anfrage

auf Anfrage



## Treppenkantenprofil 5x15mm Stair Nosing 5x15mm

Zur Verlegung von Belägen bis 5mm, mit Einschub. Gebohrt und gesenkt. Länge 270cm.  
Stair nosing for floor coverings up to 5mm, with insertion. Drilled and countersunk. Length 270cm.

**Art.nr.**  
No.

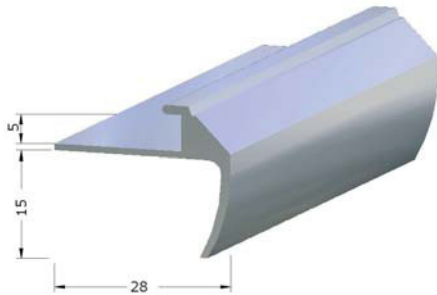

**10 x 270cm**

<b>Alu silber</b> <i>Alu silver</i>	11.10980
<b>Alu gold</b> <i>Alu gold</i>	11.10990
<b>Alu bronze</b> <i>Alu bronze</i>	11.11000



## Treppenkantenprofil 5x7mm Stair Nosing 5x7mm

Zur Verlegung von Belägen bis 5mm, mit Einschub und Riffelung. Gebohrt und gesenkt. Länge 270cm.  
Stair nosing for floor coverings up to 5mm, with insertion, fluted. Drilled and countersunk. Length 270cm.

**Art.nr.**  
No.

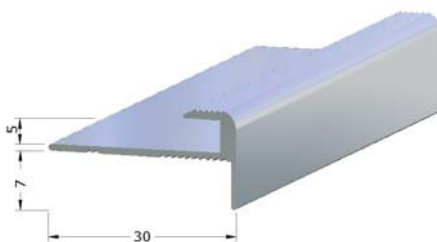

**10 x 270cm**

<b>Alu silber</b> <i>Alu silver</i>	11.11067
<b>Alu gold</b> <i>Alu gold</i>	11.11068
<b>Alu bronze</b> <i>Alu bronze</i>	11.11069



## Vari - Treppenkantenprofil Vari - Stair Nosing

Zur Verlegung von Teppichbelägen auf Treppen und Absätzen. Durch Zusammendrücken des oberen Abschlusses wird der Belag dauerhaft eingeklemmt. Gebohrt und gesenkt. Länge 300cm.  
Stair nosing for carpets on stairs and edges, adaptable. Drilled and countersunk. Length 300cm.

**Art.nr.**  
No.

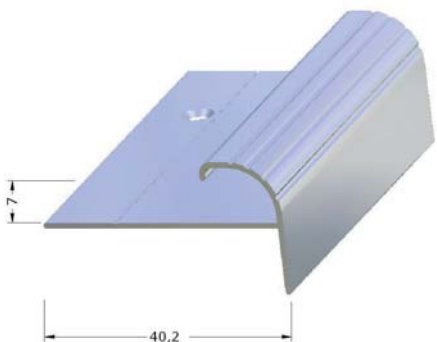

**10 x 300cm**

<b>Alu silber</b> <i>Alu silver</i>	11.11063
-------------------------------------	----------



## Treppenkantenprofil ‚Industria‘ mit Antirutscheinlage Stair Nosing ‚Industria‘ with anti-slip insert

Zur universellen Verlegung auf Treppen, zur Sanierung auch im Objektbereich. Auf Null auslaufend. Mit hochwertiger 1,6mm dicken Antirutscheinlage 49,1mm breit, selbstklebend, Rolle à 6m. Gebohrt und gesenkt. Länge 300cm (600cm auf Anfrage). Lieferung Profil ohne Einlage. *All-purpose profile for stairs, for renovation and for industrial use. With premium exchangeable anti-slip insertion, 1,6mm thick, 49,1mm wide, self-adhesive, roll per 6m. Drilled and countersunk. Length 300cm (600cm upon request). Delivery profile without insert.*

**auch für Außenbereiche  
qualified for outdoor**

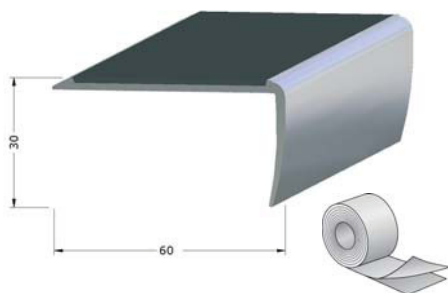

	10 x 300cm	Rolle à 6m
<b>Alu silber</b> <i>Alu silver</i>	11.10944	
<b>Alu gold</b> <i>Alu gold</i>	11.10946	
<b>Alu natur</b> <i>Alu nature</i>	11.10945	
<b>Antirutscheinlage schwarz</b> <i>insert black</i>		11.10947B
<b>Antirutscheinlage schiefergrau</b> <i>insert grey</i>		11.10948B

**Art.nr.**  
No.

**Art.nr.**  
No.

## Treppenkantenprofil 18x38mm mit Einlage Stair Nosing 18x38mm with insert

Universell auf allen Treppen einsetzbar. Auf Null auslaufend, mit abgerundeter Kante. Optional mit auswechselbarer Antirutscheinlage, 14mm breit, Rolle à 25m, selbstklebend. Gebohrt und gesenkt. Länge 300cm. Lieferung Profil ohne Einlage. *All-purpose profile for stairs and edges. Ends to zero, edge rounded. Optional with exchangeable anti-slip insert, 14mm wide, roll per 25m, self-adhesive. Drilled and countersunk. Length 300cm. Delivery profile without insert.*

**Art.nr.**  
No.

**Art.nr.**  
No.

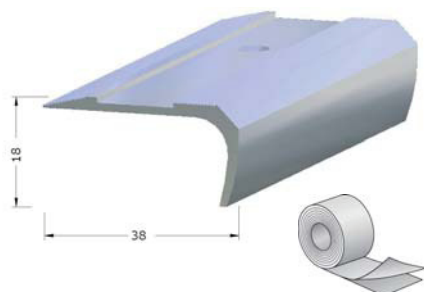

	10 x 300cm	Rolle à 25m
<b>Alu silber</b> <i>Alu silver</i>	11.10890	
<b>Alu gold</b> <i>Alu gold</i>	11.10900	
<b>Alu bronze</b> <i>Alu bronze</i>	11.10910	
<b>Einlage 14 mm schwarz</b> <i>insert 14 mm black</i>		11.10920B
<b>Einlage 14 mm braun</b> <i>insert 14 mm brown</i>		11.10930B
<b>Einlage 14 mm beige</b> <i>insert 14 mm beige</i>		11.10940B

## Treppenkantenprofil 30x58mm mit Einlage Stair Nosing 30x58mm with insert

Universell auf allen Treppen einsetzbar. Auf Null auslaufend, mit abgerundeter Kante. Optional mit auswechselbarer Antirutscheinlage, 28mm breit, Rolle à 25m, selbstklebend. Gebohrt und gesenkt. Länge 300cm. Lieferung Profil ohne Einlage. *All-purpose profile for stairs and edges. Ends to zero, edge rounded. Optional with exchangeable anti-slip insert, 28mm wide, roll per 25m, self-adhesive. Drilled and countersunk. Length 300cm. Delivery profile without insert.*

**Art.nr.**  
No.

**Art.nr.**  
No.

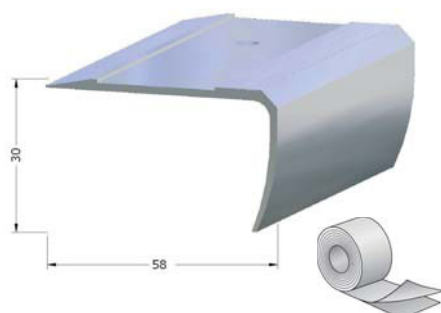

	10 x 300cm	Rolle à 25m
<b>Alu silber</b> <i>Alu silver</i>	11.10911	
<b>Alu gold</b> <i>Alu gold</i>	11.10912	
<b>Einlage 28 mm schwarz</b> <i>insert 28 mm black</i>		11.10921B
<b>Einlage 28 mm braun</b> <i>insert 28 mm brown</i>		11.10931B
<b>Einlage 28 mm beige</b> <i>insert 28 mm beige</i>		11.10941B

## Treppenkantenprofil 13,5mm mit PVC-Einlage Stair Nosing 13,5mm with PVC-insert

Treppenprofil als Abschluss zu Belägen bis 4,5mm z.B. Teppich. Profil mit auswechselbarer PVC-Antirutschleinlage, 25mm breit, Rolle à 25m. Gebohrt und gesenkt. Länge Profil 300cm. Lieferung Profil ohne PVC-Einlage. *Stair nosing as edge trim to floor coverings up to 4,5mm. Profile with exchangeable PVC anti-slip inserts, 25mm wide, roll per 25m. Drilled and countersunk. Length profile 300cm. Delivery profile without PVC-insert.*

**Art.nr.**  
No.

**Art.nr.**  
No.

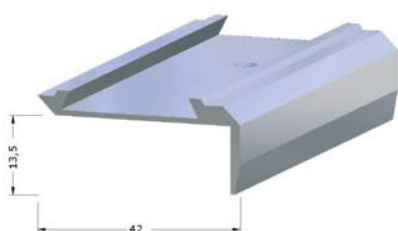

**10 x 300cm**

**Rolle à 25m**

**Alu silber** *Alu silver*

11.10750

**PVC-Einlage schwarz** *PVC insert black*

11.10850B

**PVC-Einlage grau** *PVC insert grey*

11.10851B

**PVC-Einlage braun** *PVC insert brown*

11.10860B

**PVC-Einlage schwarz gerillt** *PVC insert black fluted*

11.10880B

## Treppenkantenprofil 28mm mit PVC-Einlage Stair Nosing 28mm with PVC-insert

Treppenprofil als Abschluss zu Belägen bis 4,5mm z.B. Teppich. Profil mit auswechselbarer PVC-Antirutschleinlage, 25mm breit, Rolle à 25m. Gebohrt und gesenkt. Länge Profil 300cm. Lieferung Profil ohne PVC-Einlage. *Stair nosing as edge trim to floor coverings up to 4,5mm. Profile with exchangeable PVC anti-slip inserts, 25mm wide, roll per 25m. Drilled and countersunk. Length profile 300cm. Delivery profile without PVC-insert.*

**Art.nr.**  
No.

**Art.nr.**  
No.

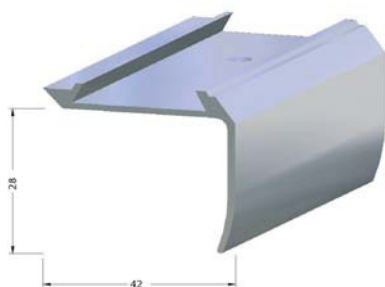

**10 x 300cm**

**Rolle à 25m**

**Alu silber** *Alu silver*

11.10790

**Messing poliert** *Brass polished*

11.10780

**PVC-Einlage schwarz** *PVC insert black*

11.10850B

**PVC-Einlage grau** *PVC insert grey*

11.10851B

**PVC-Einlage braun** *PVC insert brown*

11.10860B

**PVC-Einlage schwarz gerillt** *PVC insert black fluted*

11.10880B

## Kombi - Treppenkantenprofil 28mm mit PVC-Einlage Kombi Stair Nosing 28mm with PVC-insert

Treppenprofil für Beläge bis 5mm, mit umschlagbarem Endteil zum Einklemmen von Belägen. Geeignet für Renovierungen. Profil mit auswechselbarer PVC-Antirutschleinlage, 25mm breit, Rolle à 25m. Gebohrt und gesenkt. Länge 300cm. *Stair nosing with adaptable back part, for floor coverings up to 5mm, recommended for renovations. Profile with exchangeable PVC anti-slip inserts, 25mm wide, roll per 25m. Drilled and countersunk. Length 300cm.*

**Art.nr.**  
No.

**Art.nr.**  
No.

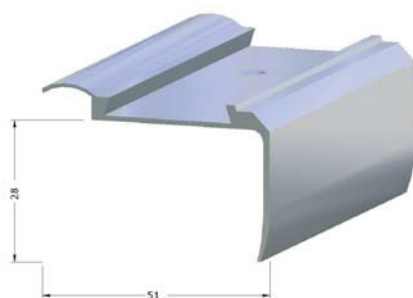

**10 x 300cm**

**Rolle à 25m**

**Alu silber** *Alu silver*

11.10820

**PVC-Einlage schwarz** *PVC insert black*

11.10850B

**PVC-Einlage grau** *PVC insert grey*

11.10851B

**PVC-Einlage braun** *PVC insert brown*

11.10860B

**PVC-Einlage schwarz gerillt** *PVC insert black fluted*

11.10880B

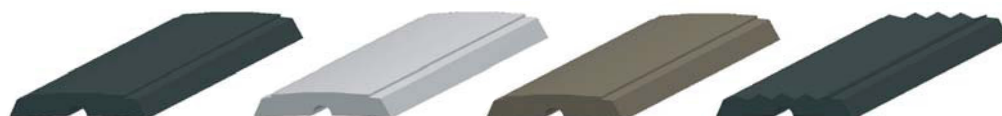

Estrichprofile

*Angle Edges for tiles*



## Estrichprofile für Fliesen von 2 bis 22mm Angle Edges for tiles from 2 to 22mm

Individuell einsetzbares Abschlussprofil, für Fliesen und alle anderen Bodenbeläge einsetzbar. Winkelprofil mit Ausstanzung zur Verlegung im Estrich- oder Kleberbett.  
All-purpose edge trims, for tiles and all other floor coverings. Angle edge with special cuttings for laying in screed or adhesive.

**Art.nr.**  
No.

**10 x 250cm**

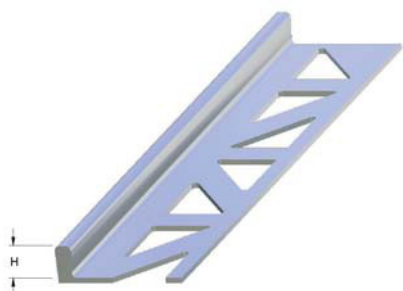

<b>Alu 2mm</b>	11.15004
<b>Alu 3mm</b>	11.15005
<b>Alu 4,5mm</b>	11.15010
<b>Alu 6mm</b>	11.15015
<b>Alu 8mm</b>	11.15020
<b>Alu 10mm</b>	11.15025
<b>Alu 11mm</b>	11.15026
<b>Alu 12,5mm</b>	11.15030
<b>Alu 15mm</b>	11.15035
<b>Alu 18,5mm</b>	11.15040
<b>Alu 20mm</b>	11.15045
<b>Alu 22mm</b>	11.15050



<b>Messing 3mm Brass</b>	11.15070
<b>Messing 4,5mm Brass</b>	11.15075
<b>Messing 6mm Brass</b>	11.15080
<b>Messing 8mm Brass</b>	11.15085
<b>Messing 10mm Brass</b>	11.15090
<b>Messing 11mm Brass</b>	11.15094
<b>Messing 12,5mm Brass</b>	11.15095
<b>Messing 15mm Brass</b>	11.15100
<b>Messing 18,5mm Brass</b>	11.15101
<b>Messing 20mm Brass</b>	11.15103
<b>Messing 22mm Brass</b>	11.15105

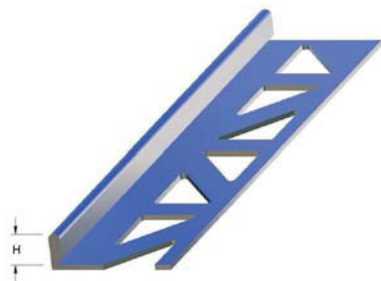

<b>Edelstahl 2mm Stainless steel</b>	11.15114
<b>Edelstahl 3mm Stainless steel</b>	11.15115
<b>Edelstahl 4,5mm Stainless steel</b>	11.15120
<b>Edelstahl 6mm Stainless steel</b>	11.15125
<b>Edelstahl 8mm Stainless steel</b>	11.15130
<b>Edelstahl 10mm Stainless steel</b>	11.15135
<b>Edelstahl 11mm Stainless steel</b>	11.15136
<b>Edelstahl 12,5mm Stainless steel</b>	11.15140
<b>Edelstahl 15mm Stainless steel</b>	11.15145
<b>Edelstahl 20mm Stainless steel</b>	11.15146

## Dehnfugenprofil für Fliesen von 3 bis 22mm Expansion joint for tiles from 3 to 22mm

Dehnfugenprofil mit grauer Kunststoffeinlage, mit 10mm Sichtkante. Mit Sonderausstattung zur Verlegung im Estrich- oder Kleberbett. Angle edges with grey rubber joint, 10mm total. Special cuttings for laying in screed or adhesive.

**Art.nr.**  
No.

**10 x 250cm**

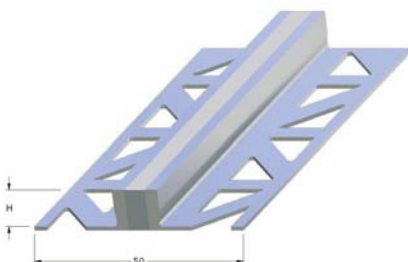

<b>Alu 3mm</b>	11.15200
<b>Alu 4,5mm</b>	11.15210
<b>Alu 6mm</b>	11.15220
<b>Alu 8mm</b>	11.15230
<b>Alu 10mm</b>	11.15240
<b>Alu 12,5mm</b>	11.15250

Aluminium bis 30mm auf Anfrage  
Aluminium up to 30mm upon request

Edelstahl auf Anfrage  
Stainless steel upon request



## Flexible Estrichprofile für Fliesen von 2-22mm – zum Biegen Flexible Angle Edges for tiles from 2-22mm – for bending

Universell einsetzbares Abschlussprofil, Verlegung im Estrich- oder Kleberbett. Winkelprofil mit Sonderausstanzung zum Biegen von runden Formen. Mindestmenge 25m.

All-purpose edge trims, for laying in screed or adhesive. Angle edges with special cuttings for bending of round forms. Minimum quantity 25m.

**Art.nr.**  
No.

**10 x 250cm**



<b>Alu 2mm</b>	11.15330
<b>Alu 3mm</b>	11.15335
<b>Alu 4,5mm</b>	11.15340
<b>Alu 6mm</b>	11.15345
<b>Alu 8mm</b>	11.15350
<b>Alu 10mm</b>	11.15355
<b>Alu 12,5mm</b>	11.15360
<b>Alu 15mm</b>	11.15065
<b>Alu 18,5mm</b>	11.15370
<b>Alu 20mm</b>	11.15375
<b>Alu 22mm</b>	11.15380



<b>Messing 3mm Brass</b>	11.15385
<b>Messing 4,5mm Brass</b>	11.15390
<b>Messing 6mm Brass</b>	11.15395
<b>Messing 8mm Brass</b>	11.15400
<b>Messing 10mm Brass</b>	11.15405
<b>Messing 12,5mm Brass</b>	11.15410
<b>Messing 15mm Brass</b>	11.15415
<b>Messing 18,5mm Brass</b>	11.15420
<b>Messing 20mm Brass</b>	11.15425
<b>Messing 22mm Brass</b>	11.15430



<b>Edelstahl 3mm Stainless steel</b>	11.15435
<b>Edelstahl 4,5mm Stainless steel</b>	11.15440
<b>Edelstahl 6mm Stainless steel</b>	11.15445
<b>Edelstahl 8mm Stainless steel</b>	11.15450
<b>Edelstahl 10mm Stainless steel</b>	11.15455
<b>Edelstahl 12,5mm Stainless steel</b>	11.15460

## Biegegerät für Estrichprofile mit Sonderausstanzung Curver for bending flexible angle edges

Geeignet für Estrichprofile und T-Profile.  
Suitable for flexible angle edges and T-profiles

**Art.nr.**  
No.



**Biegegerät konkav und konvex** 11.15000L  
Curver concave and convex

Verpackungseinheit: 10 Stangen  
Packing unit: 10 bars

Treppenstangen, Reparaturwinkel, Nagelleisten  
*Stairrods, Metal Angles, Carpet Grippers*



**Treppendreikantstange 16x16mm mit Ösen**  
**Stairrods triangular 16x16mm with clips**

Zur Verlegung von Teppichläufern auf Treppen. Viertelkreisprofil in Verbindung mit außen geschlossenen Ösen. Länge 300cm. *For laying carpets on stairs. Triangular profile in conjunction with clip, outer side closed. Length 300cm.*

**Art.nr.**  
No.

**Art.nr.**  
No.



**10 x 300cm**

**Pack à 10 Paar**  
Pack a 10 pairs

<b>Alu silber</b> <i>Alu silver</i>	11.11258
<b>Alu gold</b> <i>Alu gold bright</i>	11.11225

<b>Öse geschlossen Messing</b> <i>Clip outer side closed brass</i>	11.11230 B
<b>Öse geschlossen vernickelt</b> <i>Clip outer side closed nickel-plated</i>	11.11259 B

**Treppenläuferrohr 11mm mit Ösen**  
**Stairrods 11mm with clips**

Zur Verlegung von Teppichläufern auf Treppen. Treppenläuferrohr Ø 11mm in Verbindung mit verschiedenen dekorativen Ösen. Länge 300cm. *For laying carpets on stairs. Stairrod Ø 11mm in conjunction with different decorative clips. Length 300cm.*

**Art.nr.**  
No.

**Art.nr.**  
No.



**10 x 300cm**

**Pack à 10 Paar**  
Pack a 10 pairs

<b>Alu silber</b> <i>Alu silver</i>	11.11194
<b>Alu gold</b> <i>Alu gold bright</i>	11.11195

<b>Eichelendknöpfe 11mm Messing</b> <i>End stops 11mm brass</i>	11.11196 B
<b>Eichelendknöpfe 11mm vernickelt</b> <i>End stops 11mm nickel-plated</i>	11.11197 B

<b>Trägeröse 11mm Messing</b> <i>End stops 11mm brass</i>	11.11198 B
<b>Trägeröse 11mm vernickelt</b> <i>End stops 11mm nickel-plated</i>	11.11214 B

<b>Ringöse 11mm Messing</b> <i>Ring clip 11mm brass</i>	11.11202 B
<b>Ringöse 11mm vernickelt</b> <i>Ring clip 11mm nickel-plated</i>	11.11256 B

<b>Fixi-Sicherung 11mm Messing</b> <i>'Fixi'-clip 11mm brass</i>	11.11192 B
<b>Fixi-Sicherung 11mm vernickelt</b> <i>'Fixi'-clip 11mm nickel-plated</i>	11.11199 B

<b>Winkelöse 11mm Messing</b> <i>Clip 11mm brass</i>	11.11212 B
<b>Winkelöse 11mm vernickelt</b> <i>Clip 11mm nickel-plated</i>	11.11257 B

<b>Winkelöse geschlossen 11mm Messing</b> <i>Clip outer side closed 11mm brass</i>	11.11211 B
<b>Winkelöse geschlossen 11mm vernickelt</b> <i>Clip outer side closed 11mm nickel-plated</i>	11.11213 B

**Reparaturwinkel für Betontreppen**  
**Metal angle for repairing concrete stairs**

Typ S für Beton. 40mm Auflage, 20mm Fuß, Länge 100cm, inklusive Schrauben und Dübel. *Typ S for concrete, 40mm width, 20mm depth, length 100cm, screws and dowels included.*

**Art.nr.**  
No.



**30 x 100cm**

11.11100B

**Reparaturwinkel für Holztreppen**  
**Metal angle for repairing wooden stairs**

Zur Renovierung von Holztreppen. 40mm Auflage, 38mm Fuß, Länge 100cm. Inklusive Schraubnägel. *For renovating wooden stairs. 40mm width, 38mm depth, length 100cm, screws included.*

**Art.nr.**  
No.



**25 x 100cm**

11.11110B

**Reparaturwinkel für Holztreppen**  
**Metal angle for repairing wooden stairs**

Zur Renovierung von Holztreppen. 40mm Auflage, 20mm Fuß, Länge 100cm. Inklusive Schraubnägel. *For renovating wooden stairs. 40mm width, 20mm depth, length 100cm, screws included.*

**Art.nr.**  
No.



**50 x 100cm**

11.11120B

**Nagelleisten 2-reihig**  
**Carpet Gripper 2 rowed**

Zum Verspannen von Teppichen. 2-reihig. Nagelhöhe 5mm. Länge 152,4cm. *For stretching carpets. 2 rowed. Nail height 5mm. Length 152,4cm*

**Art.nr.**  
No.

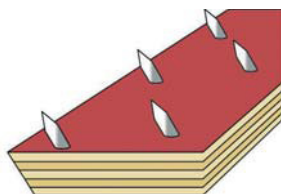

**100 x 152,4cm**

11.10010B

**Nagelleisten 3-reihig**  
**Carpet Gripper 3 rowed**

Zum Verspannen von Teppichen. 3-reihig. Nagelhöhe 4mm. Länge 122cm. *For stretching carpets. 3 rowed. Nail height 4mm. Length 122cm*

**Art.nr.**  
No.

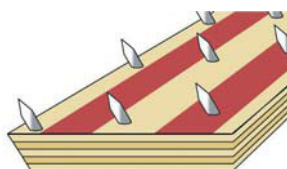

**50 x 122cm**

11.10050B

**Roll Antirutschband****Roll anti slipping adhesive tape**

Gewährleistet Trittsicherheit auf Treppen, im Eingangsbereich, in Feuchträumen, sowie im Außenbereich. Zur Verlegung auf rutschigen Flächen. Selbstklebendes, sehr raues Kunststoffband mit Granulatbeschichtung. Abriebfestigkeit von Industriediamanten. Rutschhemmung R13. Widersteht den meisten Chemikalien, temperaturbeständig von -20°C bis +60°C. 50mm breit, Rolle á 18,3m.

Guarantees anti slipping on stairs, at entrances, in humid rooms, as well as outside. For laying on slippery surfaces. Self-adhesive, very rough tape with granulate material coating. Wear resistance compared with industrial diamonds. Anti-slip property R13. Resists most chemicals, temperature range from -20°C to +60°C. 50mm wide, roll á 18,3m.

**Art.nr.**

No.

<b>Schwarz</b> <i>black</i>	14.11160F
<b>Transparent</b> <i>transparent</i>	14.11161F
<b>Grau</b> <i>grey</i>	14.11165F
<b>Nachtleuchtend</b> <i>fluorescent</i>	14.11166F

Weitere Neonfarben auf Anfrage  
Further neon colours upon request

**Schrauben und Kleber für Profile****Screws and adhesive for profiles**

**Linsensenkschrauben mit Kreuzschlitz**, 3x30mm, Pack á 200 Stück. Zur Verschraubung vorgebohrter Profile, z.B. Nahtdeckprofilen. *Recessed head raised fillister head screw 3x30mm, pack of 200 screws. For screwing drilled profiles.*

**Art.nr.**

No.



<b>vermessingt</b> <i>brass-plated</i>	21.12161B
<b>vernickelt</b> <i>nickel-plated</i>	21.12181B
<b>bronze</b> <i>bronze</i>	21.12201B
<b>Edelstahl</b> <i>stainless steel</i>	21.12191B

**Flachkopfschrauben mit Kreuzschlitz**, 3x30mm, Pack á 200 Stück. Zur Verschraubung vorgebohrter Profile. *Slotted pan head screw 3x30mm, pack of 200 screws. For screwing drilled profiles.*

**Art.nr.**

No.



<b>vermessingt</b> <i>brass-plated</i>	21.12301B
<b>vernickelt</b> <i>nickel-plated</i>	21.12311B
<b>bronze</b> <i>bronze</i>	21.12321B
<b>Edelstahl</b> <i>stainless steel</i>	21.12331B

**Kreuzschlitzschrauben für Parkettsystem** „Roll“, 2,9x9,5mm und 2,9x13mm, Pack á 200 Stück. Zur Verschraubung der Deckelprofile in den Basisprofilen. *Crosshead screw, pack of 200 screws. For screwing drilled profiles of profile system – cover profile in base profile.*

**Art.nr.**

No.

<b>vernickelt 9,5mm</b> <i>nickel-plated 9,5mm</i>	21.12330B
<b>vermessingt 9,5mm</b> <i>brass-plated 9,5mm</i>	21.12340B
<b>bronze 9,5mm</b> <i>bronze 9,5mm</i>	21.12350B
<b>edelstahlfarben 9,5mm</b> <i>stainless steel 9,5mm</i>	21.12355B

<b>vernickelt 13mm</b> <i>nickel-plated 13mm</i>	21.12332B
<b>vermessingt 13mm</b> <i>brass-plated 13mm</i>	21.12342B
<b>bronze 13mm</b> <i>bronze 13mm</i>	21.12352B
<b>edelstahlfarben 13mm</b> <i>stainless steel 13mm</i>	21.12362B

**Längere Schrauben für 22mm Parkett auf Anfrage**

Longer screws for 22mm parquet upon request



### PU-Montagekleber

#### PU assembly adhesive

Gebrauchsfertiger, lösemittelfreier Einkomponenten-Klebstoff. Schnell aushärtender Polyurethan-Montageklebstoff mit extrem starker Haftung auf fast allen am Bau vorkommenden Untergründen. Geeignet für Sockelleisten, Türfutter, Tafelbretter, Holz, Metall, Natur- und Kunststein, Hart-PVC, PUR-Schaum, diverse Kunststoffe usw. Nach der Aushärtung schleif- und überlackierbar. Wärmebeständig bis +110°C, wasserfest gemäß DIN EN 204 – D4. Besonders empfohlen zur Verlegung von ungebohrten Metallprofilen durch die elastische Aushärtung! Karton à 12 Stück à 470g.

*Ready-made 1-component adhesive, solvent-free. Very fast curing and extreme strength adhesion. Can be ground and varnished after curing. Suitable for all kind of building materials: base boards, door cases, wood, metal and stone, hard PVC. Heat resistant till +110°C, water proof according to DIN EN 204 - D4. Recommended for undrilled metal profiles because of flexible curing. Box of 12 units, containing 470g each.*



**Art.nr.**  
No.

**PU-Montagekleber**  
PU-assembly adhesive

18.12985H

### SB-Profile Verkaufsständer

#### Sales stand for profiles in DIY-package

SB-Ständer mit 32 Haken. 1,25m breit und 2,00m hoch.  
DIY sales stand with 32 hooks. 1,25m x 2,00m

**Art.nr.**  
No.

**Verkaufsständer**  
Sales Stand

10.00500

Andere Größen und Ausführungen auf Anfrage  
Other sizes and versions upon request





Albstrasse 12  
72820 Sonnenbühl  
Deutschland

Telefon +49 (0) 7128/9280-0  
Telefax +49 (0) 7128/9280-11

[info@roll-gmbh.de](mailto:info@roll-gmbh.de)  
[www.roll-gmbh.de](http://www.roll-gmbh.de)  
[www.roll-profile.de](http://www.roll-profile.de)