

BELEUCHTUNG, STURZTEILE

Rückspiegel • Rearview Mirrors • Rétroviseur



Best.-Nr.32 001,
links, 10mm
€ 9,95
Best.-Nr.32 002,
rechts, 10mm
€ 9,95

Best.-Nr. 32 006,
10mm
€ 29,95

Best.-Nr. 32 009,
10mm
€ 9,95

Best.-Nr.32 010,
links, 5cm
€ 24,95
Best.-Nr.32 011,
rechts, 5cm
€ 24,95



Best.-Nr. 32 004,
links, 4cm
€ 24,95
Best.-Nr. 32 005,
rechts, 4cm
€ 24,95

Best.-Nr. 32 018,
links, 4cm
€ 29,95
Best.-Nr. 32 019,
rechts, 4cm
€ 29,95

Best.-Nr.32 012,
links, 4,5cm
€ 19,95
Best.-Nr.32 013,
rechts, 4,5cm
€ 19,95

Best.-Nr. 32 014,
links, 10mm
€ 7,95
Best.-Nr. 32 015,
rechts, 10mm
€ 7,95



Best.-Nr.32 016,
links, 5cm
€ 29,95
Best.-Nr.32 017,
rechts, 5cm
€ 29,95

Best.-Nr. 32 020,
links, 10mm
€ 17,95
Best.-Nr. 32 021,
rechts, 10mm
€ 17,95

Best.-Nr.32 022,
rechts, 4,5cm
€ 17,95
Best.-Nr.32 023,
links, 4,5cm
€ 17,95

Best.-Nr.32 024,
links, 10mm
€ 17,95
Best.-Nr.32 025,
rechts, 10mm
€ 17,95

BELEUCHTUNG, STURZTEILE

Rückspiegel • Rearview Mirrors • Rétroviseur



Best.-Nr.32 026,
links, 10mm
€ 12,95
Best.-Nr.32 027,
rechts, 10mm
€ 12,95

Best.-Nr. 32 028,
links, 5cm
€ 39,95
Best.-Nr. 32 029,
rechts, 5cm
€ 39,95

Best.-Nr. 32 032,
links, 10mm
€ 14,95
Best.-Nr. 32 033,
rechts, 10mm
€ 14,95

Best.-Nr. 32 034,
links, 3cm
€ 19,95
Best.-Nr. 32 035,
rechts, 3cm
€ 19,95

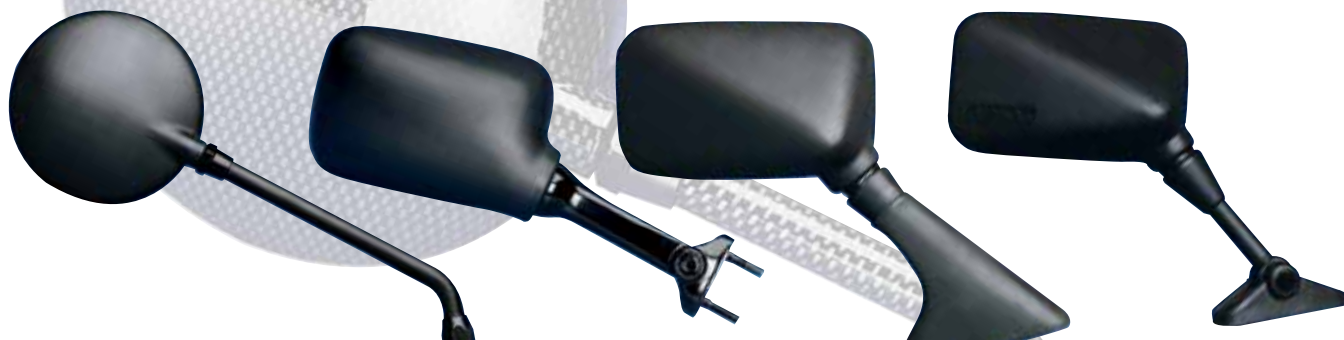

Best.-Nr. 32 036,
10mm
€ 14,95

Best.-Nr. 32 037,
links, 3cm
€ 18,95
Best.-Nr. 32 038,
rechts, 3cm
€ 18,95

Best.-Nr. 32 039,
links, 6cm
€ 14,95
Best.-Nr. 32 040,
rechts, 6cm
€ 14,95

Best.-Nr. 32 041,
links
€ 14,95
Best.-Nr. 32 042,
rechts
€ 14,95



Best.-Nr. 32 043,
links, 3cm
€ 19,95
Best.-Nr. 32 044,
rechts, 3cm
€ 19,95

Best.-Nr. 32 050,
links, 3cm
€ 19,95
Best.-Nr. 32 051,
rechts, 3cm
€ 19,95

Best.-Nr. 32 052,
links, 10mm
€ 14,95
Best.-Nr. 32 053,
rechts, 10mm
€ 14,95

Best.-Nr. 32 060,
links, 10mm
€ 12,95
Best.-Nr. 32 061,
rechts, 10mm
€ 12,95

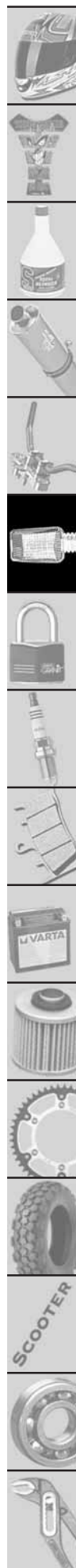

BELEUCHTUNG, STURZTEILE

Rückspiegel • Rearview Mirrors • Rétroviseur



Bestell-Nr.		€
links 32062	M8	14,95
rechts 32063	M8	14,95



Bestell-Nr.		€
links 32064		24,95
rechts 32065		24,95



Bestell-Nr.		€
links 32066	6mm	69,95
rechts 32067	6mm	69,95



Bestell-Nr.		€
links 32068	6mm	54,95
rechts 32069	6mm	54,95



Bestell-Nr.		€
32078	10x1,25mm	39,95



Bestell-Nr.		€
32079	10x1,25mm	39,95



Bestell-Nr.		€
links 32080	M6	34,95
rechts 32081	M6	34,95



Bestell-Nr.		€
links 32082	M6	34,95
rechts 32083	M6	34,95

BELEUCHTUNG, STURZTEILE

Rückspiegel • Rearview Mirrors • Rétroviseur



Bestell-Nr.		€
links 32084	10x1,25mm	29,95
rechts 32085	10x1,25mm	29,95



Bestell-Nr.		€
links 32086	10x1,25mm	49,95
rechts 32087	10x1,25mm	49,95



Bestell-Nr.		€
links 32088	M8	19,95
rechts 32089	M8	19,95



Bestell-Nr.		€
links 32092	10x1,25mm	17,99
rechts 32093	10x1,25mm	17,99



Bestell-Nr.		€
links 32094	M6	39,95
rechts 32095	M6	39,95



Bestell-Nr.		€
32090	10x1,25mm	19,95



Bestell-Nr.		€
links 32108	10mm	29,95
rechts 32109	10mm	29,95



Bestell-Nr.	Universalspiegel für alle Roller mit M8 Gewinde	€
links 32208		9,95
rechts 32209		9,95



BELEUCHTUNG, STURZTEILE

Rückspiegel • Rearview Mirrors • Rétroviseur



Bestell-Nr.	Spiegel Hot Stile	€
links 32074	4 cm Lochabstand 6 mm Bolzen	49,95
rechts 32075	4 cm Lochabstand 6 mm Bolzen	49,95



Bestell-Nr.	Spiegel Hot Stile	€
links 32076	4 cm Lochabstand 6 mm Bohrung	49,95
rechts 32077	4 cm Lochabstand 6 mm Bohrung	49,95



Bestell-Nr.	Spiegel Hot Stile	€
links 32098	6 cm Lochabstand 6 mm Bohrung	49,95
rechts 32099	6 cm Lochabstand 6 mm Bohrung	49,95



Bestell-Nr.	Spiegel Hot Stile	€
links 32096	2,8 cm Lochabstand 6 mm Bolzen	49,95
rechts 32097	2,8 cm Lochabstand 6 mm Bolzen	49,95



Bestell-Nr.	Spiegel Hot Stile	€
links 32072	4 cm Lochabstand 6 mm Bohrung	49,95
rechts 32073	4 cm Lochabstand 6 mm Bohrung	49,95



Bestell-Nr.	Spiegel Hot Stile	€
links 32100	2,8 cm Lochabstand 6 mm Bolzen	49,95
rechts 32101	2,8 cm Lochabstand 6 mm Bolzen	49,95



Bestell-Nr.	Spiegel Hot Stile	€
links 32106	2,8 cm Lochabstand 6 mm Bolzen	49,95
rechts 32107	2,8 cm Lochabstand 6 mm Bolzen	49,95



Bestell-Nr.	Spiegel Hot Stile	€
links 32102	2,8 cm Lochabstand 6 mm Bolzen	49,95
rechts 32103	2,8 cm Lochabstand 6 mm Bolzen	49,95

BELEUCHTUNG, STURZTEILE

Rückspiegel • Rearview Mirrors • Rétroviseur

Baujahr	Bestell-Nr. links	€	Bestell-Nr. rechts	€	Bemerkung
APRILIA					
SR 50	32062	14,95	32063	14,95	M8 schwarz
SR 125	32062	14,95	32063	14,95	M8 schwarz
Leonardo ST 125	32064	24,95	32065	24,95	M8 schwarz
HONDA					
SJ50 Bali	32052	14,95	32053	14,95	10x1,25 schwarz
MTX 50 SE	84	32009	32009	9,95	10mm schwarz
MBX 80		32009	32009	9,95	10mm schwarz
MTX 80 C	82	32009	32009	9,95	10mm schwarz
MTX 80 RS (D,E)	83-84	32009	32009	9,95	10mm schwarz
MTX 80 R2	87	32009	32009	9,95	10mm schwarz
NSR 125 R		32080	32081	34,95	M6 schwarz
XL 185 S (Z,A,B)	79-81	32001	32002	9,95	10mm chrom
MTX 200 RW	83-85	32009	32009	9,95	10mm schwarz
XL 200 R	83	32009	32009	9,95	10mm schwarz
CB 250 N,N	79-81	32001	32002	9,95	10mm chrom
CB 250 ND	82	32001	32002	9,95	10mm chrom
CB 250 TII	79	32001	32002	9,95	10mm chrom
NX 250	88-90	32009	32009	9,95	10mm schwarz
NX 250 II	91-95	32009	32009	9,95	10mm schwarz
XL 250 S	79-81	32001	32002	9,95	10mm chrom
XL 250 R	82-84	32009	32009	9,95	10mm schwarz
CB 350 F	73	32001	32002	9,95	10mm chrom
CB 400	79	32001	32002	9,95	10mm chrom
CB 400 F,N,T	75-82	32001	32002	9,95	10mm chrom
CB 500 (R,T)	94-96	32006	32006	29,95	10mm chrom
CX 500	79-81	32001	32002	9,95	10mm chrom
XL 500 S	79-81	32001	32002	9,95	10mm chrom
XL 500 R	82	32009	32009	9,95	10mm schwarz
CB 550 K3 FOUR		32001	32002	9,95	10mm chrom
CBR 600		32082	32083	34,95	M6 schwarz
CBR 600 F	91-	32010	32011	24,95	schwarz
CBR 600 F	91-	32016	32017	29,95	carbon look
CBR 600 F		32074	32075	49,95	6 mm schwarz HOT STILE
CBR 600 RR	2003	32066	32067	69,95	6 mm schwarz
CBR 600 RR	2003	32072	32073	49,95	6mm schwarz HOT STILE
VT 600 Shadow		32078	32078	39,95	10x1,25 chrom
XL 600 V	87-96	32009	32009	9,95	10mm schwarz
CB 650 C/SC	80-82	32006	32006	29,95	10mm chrom
NX 650	88-92	32009	32009	9,95	10mm schwarz
CB 750 K(A,B,Z)	79-81	32006	32006	29,95	10mm chrom
CB 750 F,K	76-78	32001	32002	9,95	10mm chrom
VF 750 C		32086	32087	49,95	10x1,25 chrom
VF 750 C2		32086	32087	49,95	10x1,25 chrom
VT 750 C2 Shadow	ab 98	32078	32078	39,95	10x1,25 chrom
XRV 750	88-89	32009	32009	9,95	10mm schwarz
VN 800		32078	32078	39,95	10x1,25 chrom
VFR 800	2002/2003	32068	32069	54,95	6mm schwarz
VFR 800	2002/2003	32074	32075	49,95	6mm schwarz HOT STILE
CB 900 F	79-82	32006	32006	29,95	10mm chrom
CBR 900		32080	32081	34,95	M6 schwarz
CBR 900 RR		32004	32005	24,95	schwarz
CBR 900 RR		32018	32019	29,95	carbon look
CBR 900 RR		32076	32077	49,95	M6 schwarz HOT STILE
CBR 1000		32082	32083	34,95	M6 schwarz
CBR 1000 RR	2004/2006	32074	32075	49,95	M6 schwarz
CBR 1000 RR	2004/2006	32121	32120	79,95	Blinkerspiegel, alle Adapter
Varadero 1000		32084	32085	29,95	10x1,25 schwarz
VT 1000 C2		32086	32087	49,95	10x1,25 chrom
VT 1000 C3		32078	32078	39,95	10x1,25 chrom
GL 1100	80-81	32006	32006	29,95	10mm chrom
VTX 1300 S		32079	32079	39,95	10x1,25 chrom
GL 1500		32078	32078	39,95	10x1,25 chrom
VTX 1800 C		32079	32079	39,95	10x1,25 chrom
HYOSUNG					
GPS Grand Prix 125		32088	32089	19,95	M8 schwarz
RX 125 Komet		32090	32090	19,95	10x1,25 schwarz
GA 125 Cruise I	96-	32092	32093	17,95	10x1,25 chrom
GA 125 Cruise II	98-	32092	32093	17,95	10x1,25 chrom
GT 650		32090	32090	19,95	10x1,25 schwarz
KAWASAKI					
GPZ 500 S	87	32039	32040	14,95	schwarz
GPZ 500 S	88-93	32039	32040	14,95	schwarz
GPZ 600	87-89	32039	32040	14,95	schwarz
ZX-6R	-2002	32100	32101	49,95	M6 schwarz HOT STILE
ZX-6R	2003/2004	32094	32095	39,95	M6 schwarz
ZX-6R	2003/2004	32096	32097	49,95	M6 schwarz HOT STILE

SCOOTER

BELEUCHTUNG, STURZTEILE

Rückspiegel • Rearview Mirrors • Rétroviseur

	Baujahr	Bestell- Nr. links	€	Bestell- Nr. rechts	€	Bemerkung
GPZ 750 R G2	85	32041	14,95	32042	14,95	schwarz
ZX 7 R		32043	19,95	32044	19,95	schwarz
ZXR 750		32037	18,95	32038	18,95	schwarz
GPZ 900 R	84-89	32041	14,95	32042	14,95	schwarz
ZX-9R		32100	49,95	32101	49,95	M6 schwarz HOT STILE
Z 900 Z1		32036	14,95	32036	14,95	10mm schwarz
ZZ-R 1200		32098	49,95	32099	49,95	M6 schwarz HOT STILE
SUZUKI						
TS 125 ER	79-81	32026	12,95	32027	12,95	10mm schwarz
TS 185		32026	12,95	32027	12,95	10mm schwarz
DR 250 S	84-87	32032	14,95	32033	14,95	10mm schwarz
GSX 250	80-81	32026	12,95	32027	12,95	10mm schwarz
GT 250	79-81	32026	12,95	32027	12,95	10mm schwarz
TS 250 X	86-89	32032	14,95	32033	14,95	10mm schwarz
DR 400 S	80-81	32026	12,95	32027	12,95	10mm schwarz
GS 450 I,TU	81	32026	12,95	32027	12,95	10mm schwarz
DR 600 R,RU,S,SU	85-89	32032	14,95	32033	14,95	10mm schwarz
GSX 600 F		32028	39,95	32029	39,95	schwarz
RF 600		32050	19,95	32051	19,95	schwarz
DR 650		32032	14,95	32033	14,95	10mm schwarz
DR 750 S,SU	88-89	32032	14,95	32033	14,95	10mm schwarz
GS 750 (D,E)	77-79	32026	12,95	32027	12,95	10mm schwarz
GSX 750 EG	80	32026	12,95	32027	12,95	10mm schwarz
GSX 750	80-81	32026	12,95	32027	12,95	10mm schwarz
GSX-R 750 (W)	90-93	32034	12,95	32035	12,95	schwarz
GSX-R 750 (W)	96-97	32050	23,90	32051	23,90	schwarz
DR 800		32032	19,95	32033	19,95	10mm schwarz
RF 900		32050	23,90	32051	23,90	schwarz
GS 1000 E	78-80	32026	12,95	32027	12,95	10mm schwarz
GS 1000 H	78-80	32026	12,95	32027	12,95	10mm schwarz
GSX 1100 (T,X)	80-81	32026	12,95	32027	12,95	10mm schwarz
GSX 1100 E	80-81	32026	12,95	32027	12,95	10mm schwarz
GSX-R 1100 W	93-94	32034	19,95	32035	19,95	schwarz
YAMAHA						
RD 50	78-82	32014	7,95	32015	7,95	10mm schwarz
DT 80 LC	83-84	32014	7,95	32015	7,95	10mm schwarz
DT 80 LC2	85-96	32014	7,95	32015	7,95	10mm schwarz
DT 80 MX,MXS	81-84	32014	7,95	32015	7,95	10mm schwarz
RD 80 MX	81-82	32014	7,95	32015	7,95	10mm schwarz
RD 80 LC1	82-88	32014	7,95	32015	7,95	10mm schwarz
RD 80 LCII	82-88	32060	12,95	32061	12,95	10mm schwarz
RS 100 DX	79-81	32014	7,95	32015	7,95	10mm schwarz
RD 125 LC	82	32060	12,95	32061	12,95	10mm schwarz
TZR 125		32012	19,95	32013	19,95	schwarz
DT 175 MX	78-81	32014	7,95	21015	7,95	10mm schwarz
RD 200	78-79	32014	7,95	21015	7,95	10mm schwarz
DT 250 MX	79-81	32014	7,95	21015	7,95	10mm schwarz
RD 250 (S)	77-79	32060	12,95	32061	12,95	10mm schwarz
XT 250	80-87	32014	7,95	32015	7,95	10mm schwarz
DT 400 MX	79	32014	7,95	32015	7,95	10mm schwarz
RD 400 (S)	77-79	32060	12,95	32061	12,95	10mm schwarz
XS 400 (SE)	80-82	32060	12,95	32061	12,95	10mm schwarz
XT 500	78-89	32014	7,95	32015	7,95	10mm schwarz
XV 500	83	32024	17,95	32025	17,95	10mm chrom
SR 500	84-	32024	17,95	32025	17,95	10mm chrom
XJ 550		32060	12,95	32061	12,95	10mm schwarz
XT 550	82-83	32014	7,95	32015	7,95	10mm schwarz
FZR 600		32012	19,95	32013	19,95	schwarz
FZS 600 Fazer		32102	49,95	32103	49,95	M6 schwarz HOT STILE
SRX 600		32021	17,95	32020	17,95	10mm schwarz
XJ 600	84-89	32021	17,95	32020	17,95	10mm schwarz
XT 600 Z	83-84	32014	7,95	32015	7,95	10mm schwarz
YZF 600	94-96	32012	19,95	32013	19,95	schwarz
YZF R6 600		32106	49,95	32107	49,95	M6 schwarz HOT STILE
XJ 650		32060	12,95	32061	12,95	10mm schwarz
FZ 750	85-93	32023	17,95	32022	17,95	10mm schwarz
FZR 750		32012	19,95	32013	19,95	schwarz
XJ 750	84	32021	17,95	32020	17,95	10mm schwarz
XS 750 (SE)	80	32060	12,95	32061	12,95	10mm schwarz
XV 750 SE	81-82	32024	17,95	32025	17,95	10mm chrom
YZF 750	94-96	32012	19,95	32013	19,95	schwarz
TRX 850		32012	19,95	32013	19,95	schwarz
XS 850	80	32060	12,95	32061	12,95	10mm schwarz
XJ 900	93-93	32021	17,95	32020	17,95	10mm schwarz
YZF 1000 R1		32106	49,95	32107	49,95	M6 schwarz HOT STILE
FZR 1000		32012	19,95	32013	19,95	schwarz
FJ 1100	84-85	32021	17,95	32020	17,95	10mm schwarz
XS 1100	80-81	32060	12,95	32061	12,95	10mm schwarz

BELEUCHTUNG, STURZTEILE

Rückspiegel • Rearview Mirrors • Rétroviseur

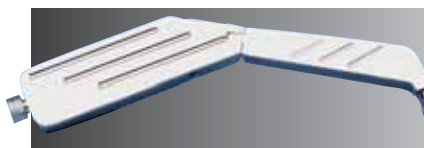

Bestell-Nr.	Ministyle Typ 1	€
verchromt eckig 10mm		
32 300	links	44,95
32 301	rechts	44,95



Bestell-Nr.	Ministyle Typ 2	€
verchromt oval 10mm		
32 310	links	39,95
32 311	rechts	39,95



Bestell-Nr.	Ministyle Typ 3	€
verchromt rund 10mm		
32 320	links	19,95
32 321	rechts	19,95



Bestell-Nr.	Chopper Style 1	€
verchromt eckig 10mm		
32 330	links	32,95
32 331	rechts	32,95



Bestell-Nr.	Chopper Style 2	€
verchromt eckig 10mm		
32 340	links	34,95
32 341	rechts	34,95



Bestell-Nr.	Chopper Style 3	€
verchromt oval 10mm		
32 350	links	29,95
32 351	rechts	29,95



Bestell-Nr.	Chopper Style 4	€
32 500	chrom 10mm rechts, rechts	39,95
32 501	chrom 10mm rechts, links	39,95



Bestell-Nr.	Chopper Style 5	€
32 510	chrom 10 mm rechts, rechts	34,95
32 511	chrom 10 mm rechts, links	34,95



Bestell-Nr.	Chopper-Spiegel California	€
32 540	chrom 10mm rechts, rechts	39,95
32 541	chrom 10mm rechts, links	39,95

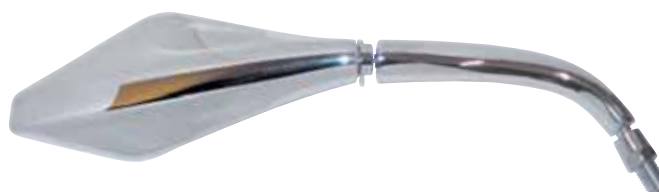

Bestell-Nr.	Chopper Style 6 Alu	€
32405	chrom 10mm links	39,95
32406	chrom 10mm rechts	39,95
32407	schwarz 10mm links	39,95
32408	schwarz 10mm rechts	39,95

die rechten Spiegel werden mit Adapter für YAMAHA geliefert

BELEUCHTUNG, STURZTEILE

Rückspiegel • Rearview Mirrors • Rétroviseur



Bestell-Nr.	Burning Mirror	€
32 123	Burning Mirror rechts/links Gewinde M8/10	39,95

Bestell-Nr.	Multi Strada	€
32 112	Multi Strada M10 x 1,25 rechts/links Gewinde	79,95
32 113	Multi Strada M10 x 1,25 links	79,95
32 122	Multi Strada M10 x 1,25 rechts	79,95



Bestell-Nr.	Stealth I	€
32 114	Stealth I black links M10 x 1,25 für Lenker	69,95
32 115	Stealth I black rechts M10 x 1,25 für Lenker incl. links Adapter	69,95
32 116	Stealth I carbon links M10 x 1,25 für Lenker	69,95
32 117	Stealth I carbon rechts M10 x 1,25 für Lenker incl. links Adapter	69,95



Bestell-Nr.	Stealth II	€
32 118	Stealth II carbon links für Verkleidung 30mm Bolzen, 47/40/40-50mm Bohrung	79,95
32 119	Stealth II carbon rechts für Verkleidung 30mm Bolzen, 47/40/40-50mm Bohrung	79,95
32 120	Stealth II black rechts für Verkleidung 30mm Bolzen, 47/40/40-50mm Bohrung	79,95
32 121	Stealth II black links für Verkleidung 30mm Bolzen, 47/40/40-50mm Bohrung	79,95

BELEUCHTUNG, STURZTEILE

Rückspiegel • Rearview Mirrors • Rétroviseur



Bestell-Nr.	Lenkerbefestigung M10x1,25	€
32 270	Formula 2000 schwarz M10x1,25 rechts	16,95
32 271	Formula 2000 schwarz M10x1,25 links	16,95
32 272	Formula 2000 carbonlock M10x1,25 rechts	19,95
32 273	Formula 2000 carbonlock M10x1,25 links	19,95
32 274	Formula 2000 verchromt M10x1,25 rechts	19,95
32 275	Formula 2000 verchromt M10x1,25 links	19,95



Bestell-Nr.	Lenkerbefestigung M8x1,25	€
32 282	Formula 2000 carbonlock M8x1,25 rechts	19,95
32 283	Formula 2000 carbonlock M8x1,25 links	19,95
32 284	Formula 2000 verchromt M8x1,25 rechts	19,95
32 285	Formula 2000 verchromt M8x1,25 links	19,95



Bestell-Nr.	F1-Spiegelsatz	€
32 200	kurz, schwarz	17,95
32 201	kurz, carbon-Look	21,95



Bestell-Nr.	Spiegel universal	€
32 205	10mm schwarz R/L	12,95



Bestell-Nr.	Spiegel universal	€
32 206	10mm verchromt links	14,95
32 207	10mm verchromt rechts	14,95

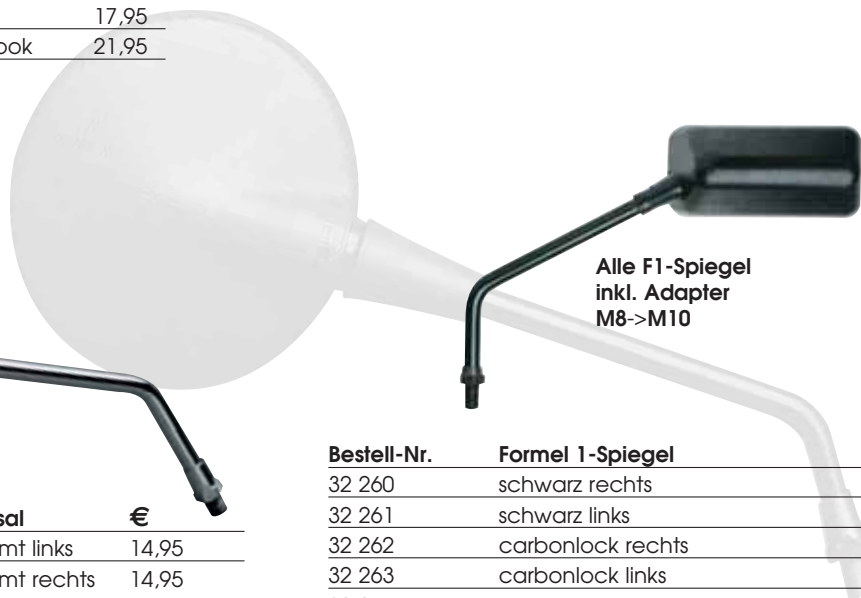

Alle F1-Spiegel
inkl. Adapter
M8->M10

Bestell-Nr.	Formel 1-Spiegel	€
32 260	schwarz rechts	16,95
32 261	schwarz links	16,95
32 262	carbonlock rechts	21,95
32 263	carbonlock links	21,95
32 264	chrom rechts	24,95
32 265	chrom links	24,95
32 266	matt schwarz rechts	21,95
32 267	matt schwarz links	21,95



BELEUCHTUNG, STURZTEILE

Rückspiegel • Rearview Mirrors • Rétroviseur

Bestell-Nr.	Chromspiegel Heavy lang	€
32 370	10mm, rechts/links	22,95

Bestell-Nr.	Chromspiegel Heavy lang f. Yamaha	€
32 372	10mm, rechts	22,95

Bestell-Nr.	Chromspiegel Heavy kurz	€
32 360	10mm, rechts/links	22,95

Bestell-Nr.	Chromspiegel Heavy kurz f. Yamaha	€
32 362	10mm, rechts	22,95



Bestell-Nr.	Spiegel innen verstellbar	€
32 204	10mm carbon-look R/L	14,95



Bestell-Nr.	Spiegel Custom chrome	€
32 390	10mm, links verchromt	39,95
32 391	10mm, rechts verchromt	39,95

Bestell-Nr.	Befestigung an Verkleidung	€
32 290	Formula 2000 schwarz M10x1,25 rechts	17,95
32 291	Formula 2000 schwarz M10x1,25 links	17,95

32 292	Formula 2000 carbonlock M10x1,25 rechts	19,95
32 293	Formula 2000 carbonlock M10x1,25 links	19,95

32 294	Formula 2000 verchromt M10x1,25 rechts	19,95
32 295	Formula 2000 verchromt M10x1,25 links	19,95



BELEUCHTUNG, STURZTEILE

Rückspiegel • Rearview Mirrors • Rétroviseur



Bestell-Nr.	Mini Spiegel Satz Supra-Light nur ca. 120gr. Gewicht	€
32 250	M10x1,25 r/l	27,95
32 251	M10x1,25 r/l f. Yamaha	27,95
32 252	M 8mm für Scooter	27,95



Bestell-Nr.	Superbike Spiegel d:82mm	€
32 222	silber	17,95
32 223	schwarz	17,95
32 224	rot	17,95
32 225	gold	17,95
32 226	blau	17,95



Bestell-Nr.	Spiegeladaptersatz	€
32 210	10mm Links auf Rechtsgewinde. Ermöglicht die Montage aller 10mm Spiegel auf Yamaha Motorrädern	12,95



Bestell-Nr.	Spiegeladaptersatz (2)	€
32 215	10mm außen -> 8mm innen Rechtsgewinde	11,95
32 216	8mm außen -> 10mm innen Rechtsgewinde	11,95



Bestell-Nr.	Adapter für F1-Spiegel	€
32 211	schwarz M10x1,25 Rechtsgewinde	7,95
32 212	schwarz M10x1,25 Linksgewinde	7,95



Bestell-Nr.	Spiegelklemme	€
32 213	verchromt 10mm	7,95
32 214	schwarz 10mm	7,95



Bestell-Nr.	Spiegeladapter	€
32 219	schwarz, 2 Bolzen 6x20mm Abstand 28mm	7,95



Bestell-Nr.	ATV-Spiegeladapter	€
32 218	Spiegelschelle schwarz für 10mm Rechtsgewinde	10,95

BELEUCHTUNG, STURZTEILE

Blinker • Indicators • Clignotants

Bestell-Nr.	Micro-Blinker (VPE = 2) E-geprüft	€/Stck.
31830	LED Micro-Blinker schwarz-kurz	17,95
31831	LED Micro-Blinker carbonlook-kurz	18,95
31832	LED Micro-Blinker chrom-kurz	18,95
31840	LED Micro-Blinker schwarz-lang	17,95
31841	LED Micro-Blinker carbonlook-lang	18,95
31842	LED Micro-Blinker chrom-lang	18,95

Lieferung nur paarweise



Bestell-Nr.	Micro-Blinker (VPE = 2) E-geprüft	€/Stck.
31850	LED Micro-Arrow schwarz-kurz	17,95
31851	LED Micro-Arrow carbonlook-kurz	18,95
31852	LED Micro-Arrow chrom-kurz	18,95
31860	LED Micro-Arrow schwarz-lang	17,95
31861	LED Micro-Arrow carbonlook-lang	18,95
31862	LED Micro-Arrow chrom-lang	18,95

Lieferung nur paarweise

Bestell-Nr.	Micro-Blinker (VPE = 2) E-geprüft	€/Stck.
31870	LED Micro-Catye schwarz-kurz	17,95
31871	LED Micro-Catye carbonlook-kurz	18,95
31872	LED Micro-Catye chrom-kurz	18,95
31880	LED Micro-Catye schwarz-lang	17,95
31881	LED Micro-Catye carbonlook-lang	18,95
31882	LED Micro-Catye chrom-lang	18,95

Lieferung nur paarweise



BELEUCHTUNG, STURZTEILE

Blinker • Indicators • Clignotants

Bestell-Nr.	LED Small Eye (VPE = 2) E-geprüft	€/Stck.
Metallgehäuse, Abmessungen ca. 50 x 30mm (Glasfläche)		
31893	LED Small Eye mattschwarz	24,95
31894	LED Small Eye chrom	24,95

Lieferung nur paarweise

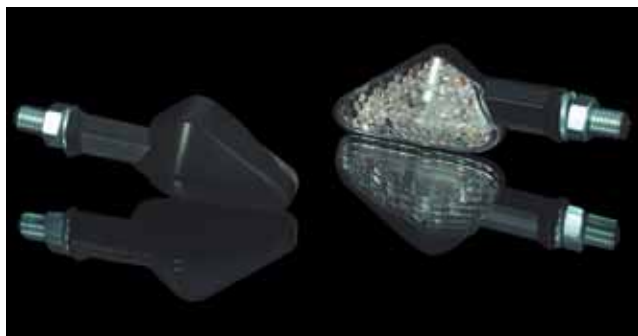

Bestell-Nr.	LED Blinker Triangle (VPE = 2) E-geprüft	€/Stck.
31764	LED Blinker Triangle schwarz kurz	22,95
31765	LED Blinker Triangle schwarz lang	22,95

Lieferung nur paarweise

Bestell-Nr.	Blinker Imola (VPE = 2) E-geprüft	€/Stck.
31760	Blinker Imola schwarz kurz	11,95
31761	Blinker Imola schwarz lang	11,95
31762	Blinker Imola carbon kurz	13,95
31763	Blinker Imola carbon lang	13,95

Lieferung nur paarweise

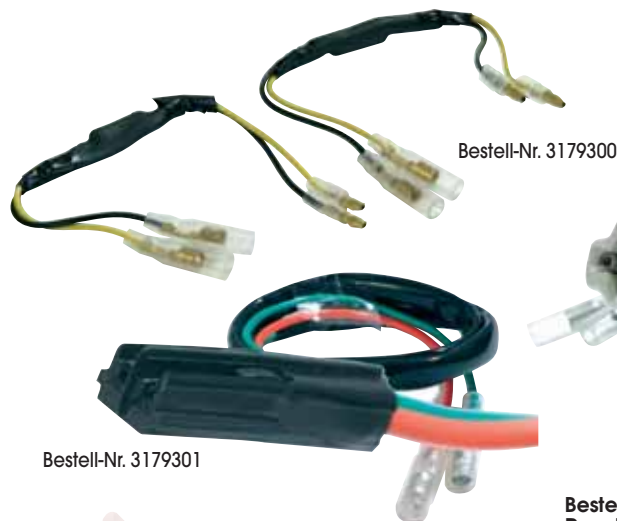

Bestell-Nr.	Adapterkabel für Miniblinker, Rundsteckhülse auf Original (paarweise)	€/Paar
3179300	Widerstand mit Anschlusskabel für LED Blinker	4,95
3179301	Honda, diverse ab Bj. 2004	5,95
3179302	Honda und Kawasaki diverse	5,95
3179303	Suzuki und Yamaha diverse	5,95
3179304	Suzuki GSXR 600, SV 650, XF 650, GSXR 750 (96-98), TL1000	5,95

Lieferung nur paarweise

BELEUCHTUNG, STURZTEILE

Blinker • Indicators • Clignotants

Bestell-Nr.	Miniblinker Little Duke (VPE = 2) E-geprüft		€/Stck.
31 620	12V 10W	kurz schwarz	9,95
31 621	12V 10W	kurz carbon-look	10,95
31 622	12V 10W	kurz chrom	10,95
31 623	12V 10W	kurz blau	10,95
31 624	12V 10W	lang schwarz	9,95
31 625	12V 10W	lang carbon-look	10,95
31 626	12V 10W	lang chrom	10,95
31 627	12V 10W	lang blau	10,95

Lieferung nur paarweise

31 628	Ersatzglas	gelb	1,99
61410	Ersatzbirne BA15S 12V 20W Halogen	VPE10	3,95
61414	Ersatzbirne BA15S 12V 21W Kugel klein	VPE10	1,95



Bestell-Nr. 31 624



Bestell-Nr. 31 625



Bestell-Nr. 31 622



Bestell-Nr. 31 623

Bestell-Nr.	Miniblinker Arrow (VPE = 2) E-geprüft		€/Stck.
31 550	kurz	schwarz	9,95
31 551	kurz	carbon	10,95
31 552	kurz	verchromt	10,95
31 553	kurz	blau	10,95
31 555	lang	schwarz	9,95
31 556	lang	carbon	10,95
31 557	lang	verchromt	10,95
31 558	lang	blau	10,95

Lieferung nur paarweise

61412	Ersatzbirne BAY9S 12V 21W Halogen	VPE10	4,45
-------	-----------------------------------	-------	------



Bestell-Nr. 31 550



Bestell-Nr. 31 552



Bestell-Nr. 31 558

Bestell-Nr. 31 556



Bestell-Nr. 31 540-541



Bestell-Nr. 31 542

Bestell-Nr.	Duc-Style E-geprüft		€/Stck.
31 540	links	Bolzen M10	7,95
31 541	rechts	Bolzen M10	7,95
31 542	links	Halter M10	7,95
31 543	rechts	Halter M10	7,95
61410	Ersatzbirne BA15S 12V 20W Halogen	VPE10	3,95
61414	Ersatzbirne BA15S 12V 21W Kugel klein	VPE10	1,95

BELEUCHTUNG, STURZTEILE

Blinker • Indicators • Clignotants



Bestell-Nr. 31 560



Bestell-Nr. 31 562



Bestell-Nr. 31 564

Bestell-Nr.	Micro Flash Glas gelb (VPE = 2)	E-geprüft	€/Stck.
31 560	kurz	schwarz	9,95
31 561	kurz	carbon	10,95
31 562	kurz	verchromt	10,95
31 563	lang	schwarz	9,95
31 564	lang	carbon	10,95
31 565	lang	verchromt	10,95

Lieferung nur paarweise

61412	Ersatzbirne BAY9S 12V 21W Halogen	VPE10	4,45
-------	-----------------------------------	-------	------

Bestell-Nr.	Micro Flash Glas dunkel getönt (VPE = 2)	E-geprüft	€/Stck.
31 570	kurz	schwarz	10,95
31 571	kurz	carbon	11,95
31 572	kurz	verchromt	11,95
31 573	lang	schwarz	10,95
31 574	lang	carbon	11,95
31 575	lang	verchromt	11,95

Lieferung nur paarweise

61412	Ersatzbirne BAY9S 12V 21W Halogen	VPE10	4,45
-------	-----------------------------------	-------	------



Bestell-Nr. 31 571



Bestell-Nr. 31 573



Bestell-Nr. 31 575



Bestell-Nr. 31 610

Bestell-Nr.	Miniblinker Universal Oval (VPE = 2)	E-geprüft	€/Stck.
31 610	Oval schwarz (gelbes Glas)		9,95

Lieferung nur paarweise

61410	Ersatzbirne BA15S 12V 20W Halogen	VPE 10	3,95
61414	Ersatzbirne BA15S 12V 21W Kugel klein	VPE 10	1,95

Bestell-Nr.	Cat Eye (VPE = 2)	E-geprüft	€/Stck.
31710	Cat Eye schwarz kurz gelb		9,95
31711	Cat Eye carbon kurz gelb		10,95
31712	Cat Eye chrom kurz gelb		10,95
31713	Cat Eye schwarz lang gelb		9,95
31714	Cat Eye carbon lang gelb		10,95
31715	Cat Eye chrom lang gelb		10,95
31720	Cat Eye schwarz kurz getönt		10,95
31721	Cat Eye carbon kurz getönt		11,95
31722	Cat Eye chrom kurz getönt		11,95
31723	Cat Eye schwarz lang getönt		10,95
31724	Cat Eye carbon lang getönt		11,95
31725	Cat Eye chrom lang getönt		11,95

Lieferung nur paarweise

61412	Ersatzbirne BAY9S 12V 21W Halogen	VPE10	4,45
-------	-----------------------------------	-------	------



Bestell-Nr. 31 710-712



Bestell-Nr. 31 720-722



BELEUCHTUNG, STURZTEILE

Blinker • Indicators • Clignotants

Bestell-Nr. Verkleidungsblinker (VPE = 2) E-geprüft €/Stck.

31 510	DAYTONA schwarz	13,90
31 511	DAYTONA chrom	14,90
31 512	DAYTONA carbon-look	14,90
31 805	DAYTONA schwarz transparent	15,90
31 806	DAYTONA carbon transparent	17,90
31 807	DAYTONA schwarz getönt	15,00
31 808	DAYTONA carbon getönt	15,90
31 816	DAYTONA LED schwarz, weißes Glas, E-geprüft	19,95
31 817	DAYTONA LED carbon, weißes Glas, E-geprüft	19,95

Lieferung nur paarweise

61 412	Ersatzbirne BAY9S 12V 21W Halogen VPE10	4,45
31 891	Miniverkleidungsblinker transparent	9,95
31 826	Miniverkleidungsblinker oval getönt	10,95

Lieferung nur paarweise

61 412	Ersatzbirne BAY9S 12V 21W Halogen VPE10	4,45
--------	---	------



Bestell-Nr. 31816



Bestell-Nr. 31826



Bestell-Nr. 31 510-512



Bestell-Nr. 31891



Bestell-Nr. 31807

Bestell-Nr. 31808



Bestell-Nr. 31805

Bestell-Nr. 31806



Bestell-Nr. Indyspacer (Satz) Adapterplatten zur

Montage von Miniblinkern/Little Duke etc.

3179101	Indy Spacer ISY1 black Yamaha	5,95
3179102	Indy Spacer ISY2 black Yamaha	5,95
3179103	Indy Spacer ISS1 black Suzuki	5,95
3179104	Indy Spacer ISS2 black Suzuki	5,95
3179105	Indy Spacer ISK1 black Kawasaki	6,95
3179106	Indy Spacer ISH1 black Honda	6,95
3179201	Indy Spacer ISY1 carbon Yamaha	7,95
3179202	Indy Spacer ISY2 carbon Yamaha	7,95
3179203	Indy Spacer ISS1 carbon Suzuki	7,95
3179204	Indy Spacer ISS2 carbon Suzuki	7,95
3179205	Indy Spacer ISK1 carbon Kawasaki	7,95
3179206	Indy Spacer ISH1 carbon Honda	7,95

Satz ist 4-teilig für 1 Blinkerpaar

Fahrzeugtyp	Bj.	vorne	hinten
Honda			
CBR600	99-	Indy Spacer ISH1	Indy Spacer ISH1
CBR600 RR	03	Indy Spacer ISH1	Indy Spacer ISH1
CBR900	92-		Indy Spacer ISH1
CB600/900 Hornet	02-	Indy Spacer ISH1	Indy Spacer ISH1
VTR1000 SP1	00-01		Indy Spacer ISH1
VTR1000 SP2	02-		Indy Spacer ISH1
Blackbird	97-		Indy Spacer ISH1

Kawasaki			
ZX6-R	98-02	Indy Spacer ISK1	Indy Spacer ISK1
ZX6-RR	03-	Indy Spacer ISK1	Indy Spacer ISK1
ZX7-R	96-	Indy Spacer ISK1	Indy Spacer ISK1
ZX9-R	98-	Indy Spacer ISK1	Indy Spacer ISK1
ZX12-R	00-02		Indy Spacer ISK1
ZRX1200S	03-	Indy Spacer ISK1	Indy Spacer ISK1
ZR7-S	03-	Indy Spacer ISK1	Indy Spacer ISK1

Suzuki			
GSX-R600/750	98-02	Indy Spacer ISS1	
GSX-R600/750/1000	01-	Indy Spacer ISS1	Indy Spacer ISS1
GSF600/1200 Bandit	01-	Indy Spacer ISS1	Indy Spacer ISS1
TL1000 S/R	97-02	Indy Spacer ISS1	

Yamaha			
YZF600	96-		Indy Spacer ISY1
FZS600 Fazer	98-03	Indy Spacer ISY1	Indy Spacer ISY1
YZF-R6	99-02	Indy Spacer ISY1	Indy Spacer ISY1
YZF-R6	03-	Indy Spacer ISY2	Indy Spacer ISY2
YZF-R1	98-01	Indy Spacer ISY1	Indy Spacer ISY1
YZF-R1	02-	Indy Spacer ISY2	Indy Spacer ISY2
FZS1000 Fazer	98-	Indy Spacer ISY1	Indy Spacer ISY1
YZF 1000	01		Indy Spacer ISY1
FJR1300	98-	Indy Spacer ISY1	

BELEUCHTUNG, STURZTEILE

Blinker • Indicators • Clignotants

Bestell-Nr.	Miniblinker beweglich (VPE = 2) E-geprüft	€/Stck.
31 640	Miniblinker kurz schwarz - flexibler Arm	6,95
31 641	Miniblinker kurz carbon - flexibler Arm	6,95
31 642	Miniblinker kurz chrom - flexibler Arm	6,95
31 643	Miniblinker lang schwarz - flexibler Arm	6,95
31 644	Miniblinker lang carbon-look - flexibler Arm	6,95
31 645	Miniblinker lang verchromt - flexibler Arm	6,95
31 646	Miniblinker kurz getönt schwarz - flexibler Arm	6,95
31 647	Miniblinker kurz getönt carbon - flexibler Arm	6,95
31 648	Miniblinker kurz getönt chrom - flexibler Arm	6,95
31 649	Miniblinker lang getönt schwarz - flexibler Arm	6,95
31 650	Miniblinker lang getönt carbon - flexibler Arm	6,95
31 651	Miniblinker lang getönt chrom - flexibler Arm	6,95

Lieferung nur paarweise

61412	Ersatzbirne BAY9S 12V 21W Halogen VPE10	4,45
-------	---	------



Bestell-Nr.
31 590

Bestell-Nr. 31 591

Bestell-Nr. 31 592

Bestell-Nr.	Transparente Miniblinker (VPE = 2) E-geprüft	€/Stck.
31 590	Miniblinker kurz schwarz - transparentes Glas	8,95
31 591	Miniblinker kurz carbon - transparentes Glas	8,95
31 592	Miniblinker kurz chrom - transparentes Glas	8,95
31 593	Miniblinker lang schwarz - transparentes Glas	8,95
31 594	Miniblinker lang carbon - transparentes Glas	8,95
31 595	Miniblinker lang chrom - transparentes Glas	8,95
31 599	Ersatzglas für transp. Miniblinker	3,95

Lieferung nur paarweise

61412	Ersatzbirne BAY9S 12V 21W Halogen VPE10	4,45
-------	---	------

Bei Problemen mit der Blinkfrequenz verwenden Sie bitte Birnen 12V 21W oder nutzen Sie das Spezialrelais 82065.

Bestell-Nr.	Minileuchten (VPE = 2)	€/Stck.
31 750	Stück transparent kurz schwarz	7,95
31 751	Stück transparent kurz carbon-look	7,95
31 753	Stück transparent lang schwarz	7,95
31 754	Stück transparent lang carbon-look	7,95
31 755	Stück transparent lang chrom	7,95
31 756	Ersatzglas Stck.	1,99

Lieferung nur paarweise

61437	Ersatzbirne T15 (Glassockel) gelb, 12V 21W VPE10	2,45
61438	Ersatzbirne T15 (Glassockel), 12V 21W VPE10	1,95

(E-geprüft aber nicht als Blinker)



Bestell-Nr.
31 640

Bestell-Nr.
31 642

Bestell-Nr.
31 644

Bestell-Nr.
31 647

Bestell-Nr.
31 648

Bestell-Nr.
31 649

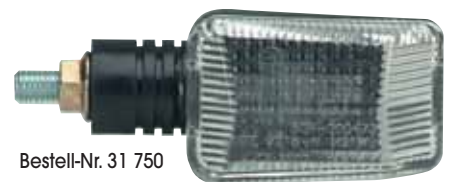

Bestell-Nr. 31 750

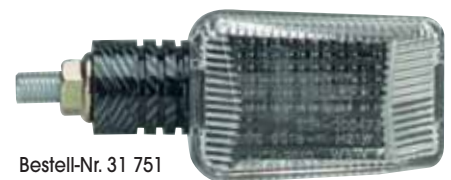

Bestell-Nr. 31 751

Lenkerendenblinker BL 1000

Der BL 1000 verbindet die Funktion eines Blinkers mit der eines Lenkerschwingungsdämpfers in Perfektion. Seine harmonische Form und die Verwendung von hochwertigen Materialien machen das Produkt zu einem besonderen Accessoire an jedem Motorrad.

Der Verpackung sind alle notwendigen Adapter zum Anbau an alle gängigen Rohrlenker beigelegt. Der BL 1000 ist als vorderer Fahrtrichtungsanzeiger E-geprüft. Umfangreiche Schutzrechte auf Design und Funktion! Made in Germany.

Best-Nr. Blinker BL 1000 und Zubehör

Best-Nr.	Blinker BL 1000 und Zubehör	Preis in €
31900	Aluminium, seidenmatt geschliffen (1)	49,95 / Stück
31901	Aluminium, schwarz pulverbeschichtet (2)	49,95 / Stück
31902	Aluminium, poliert (3)	59,95 / Stück
31907	Aluminium, chrom seidenmatt	64,95 / Stück
31903	Messing, schwarz pulverbeschichtet	59,95 / Stück
31906	Messing, chrom hochglänzend (4)	74,95 / Stück
31908	Messing, chrom seidenmatt	74,95 / Stück
31904	Edelstahl, seidenmatt (5)	66,95 / Stück
31905	Edelstahl, poliert	74,95 / Stück
31918	BL 1000 F Glas (vorne)	7,95 / Stück
31919	BL 1000 R Glas (hinten)	7,95 / Stück
31915	Halogenlampe H21W	4,50 / Stück
31913	Multifunktionssteil (ohne Befestigungsgummi und Mutter)	9,95 / Stück
31910	Gummiadaptersets* (Befestigungsgummi und Mutter) Typ 1 (ab 11,5 mm)	3,95 / Stück
31911	Gummiadaptersets* (Befestigungsgummi und Mutter) Typ 2 (ab 16,5 mm)	4,30 / Stück
31912	Gummiadaptersets* (Befestigungsgummi und Mutter) Typ 3 (ab 20 mm)	4,95 / Stück
31916	Mutter mit zusätzlichem Massekabel für Typ 2	3,30 / Stück
31917	Mutter mit zusätzlichem Massekabel für Typ 3	4,80 / Stück

* im Lieferumfang enthalten

1

2

3

4

5

SCHEWERLEICHT



Beispiel: Lenkerschwingungsdämpfer Typ M6. Umfangreiches Adaptersortiment für alle Rohrlenker (z.B. Superbikelenker, viele Originalenker) und Lenker mit eingeschweißtem M6 Aufnahmegehwinde.



Beispiel: Lenkerschwingungsdämpfer Typ M8. Passend für Lenker mit M8 Aufnahmegehwinde.

Lenkerschwingungsdämpfer LS classic und LS 1000

Diese hochwertigen Lenkerschwingungsdämpfer werden ausschließlich aus rostfreien Materialien gefertigt. Selbst die Befestigungsschrauben sind aus rostfreiem Edelstahl. Damit sind alle Voraussetzungen für eine dauerhaft edle Optik gegeben. Erhältlich in VA geschliffen, schwarz pulverbeschichtet und seidenmatt verchromt. Der LS 1000 ist durch sein Design die ideale Ergänzung zu micro 1000 und micro 1000 LED. Made in Germany.

Bestell-Nr.	Lenkerschwingungsdämpfer	Preis in €
31985	LS classic Typ M6 VA geschliffen	24,95 / Paar
31986	LS classic Typ M6 seidenmatt verchromt	24,95 / Paar
31987	LS classic Typ M6 schwarz pulverbeschichtet	24,95 / Paar
31988	LS classic Typ M8 VA geschliffen (6)	26,95 / Paar
31989	LS classic Typ M8 seidenmatt verchromt	26,95 / Paar
31990	LS classic Typ M8 schwarz pulverbeschichtet (7)	26,95 / Paar
31991	LS 1000 Typ M6 VA geschliffen	28,95 / Paar
31992	LS 1000 Typ M6 seidenmatt verchromt	28,95 / Paar
31993	LS 1000 Typ M6 schwarz pulverbeschichtet	28,95 / Paar
31994	LS 1000 Typ M8 VA geschliffen (8)	29,95 / Paar
31995	LS 1000 Typ M8 seidenmatt verchromt (9)	29,95 / Paar
31996	LS 1000 Typ M8 schwarz pulverbeschichtet (10)	29,95 / Paar

6

7

8

9

10

NEU!

micro 1000 LED white und micro 1000 LED

ECE-zugelassen für vorne und hinten

Beide micro 1000 LED-Varianten sind die zur Zeit kleinsten zugelassenen LED Blinker. Durch die hohe Lichtleistung können sie sowohl die vorderen als auch die hinteren Blinker ersetzen, und führen durch ihr Design und ihre Größe zu einem völlig neuen Erscheinungsbild des Motorrads. Ihre äußerst gelungene, harmonische Form ist identisch mit der Form des bewährten micro 1000 (Halogen). Das Herz der beiden micro 1000 LED-Varianten ist eine neue und eigens entwickelte LED-Ansteuerungstechnik. Die spezielle Kombination der integrierten MOSFET gesteuerten LONG LIFE PROTECTION GUARD Schaltung sorgt mit einer Hochleistungs- Marken-LED neuester Bauart für eine nahezu unbegrenzte Lebensdauer. Die optimale Abstrahlcharakteristik der Hochleistungsoptik und das Echtzeitansprechverhalten der LED sorgen für das „Mehr“ an Sicherheit, auf das es manchmal ankommt.*
Made in Germany.

micro 1000 (Halogen)

ECE-zugelassen für hinten

Dieser innovative und bewährte Heckblinker setzt hinsichtlich seiner Größe und seines Designs neue Maßstäbe. Er ist ein garantierter Blickfang und überzeugt durch sein hochwertiges Metallgehäuse und sein geringes Gewicht. Lieferung inklusive Silentgummibefestigung M8x20 und Halogenlampe H6W. Für alle Motorräder verwendbar*.
Made in Germany.

*u. U. sind Leistungswiderstände oder ein belastungsunabhängiger Blinkgeber zur Verringerung der Blinkfrequenz notwendig.

Zubehörbeispiele für micro 1000 LED und micro 1000:



Best.-Nr.	micro 1000 und Zubehör	Ausführung	Preis in €
319011	micro 1000 LED white	chrom (1)	49,95 / Stück
319012	micro 1000 LED white	schwarz (2)	49,95 / Stück
319013	micro 1000 LED white	chrom seidenmatt	49,95 / Stück
31997	micro 1000 LED	chrom (3)	44,95 / Stück
31998	micro 1000 LED	schwarz (4)	44,95 / Stück
31999	micro 1000 LED	chrom seidenmatt	44,95 / Stück
31930	micro 1000 (Halogen)	chrom (5)	29,95 / Stück
31931	micro 1000 (Halogen)	schwarz (6)	29,95 / Stück
31934	micro 1000 (Halogen)	chrom seidenmatt	29,95 / Stück
31940	Blinkerglas micro 1000		7,95 / Stück
31941	Halogenlampe H6W		3,95 / Stück
31937	Kugelkopfadapter für geneigte Flächen	chrom	12,50 / Stück
31938	Kugelkopfadapter für geneigte Flächen	schwarz	9,95 / Stück
31939	Kugelkopfadapter für geneigte Flächen	chrom seidenmatt (7)	12,50 / Stück
31974	starre Befestigung, M8x40	chrom	6,60 / Stück
31975	starre Befestigung, M8x40	schwarz	4,95 / Stück
31976	starre Befestigung, M8x40	chrom seidenmatt (8)	6,60 / Stück
31971	starre Befestigung, M8x20	chrom	6,60 / Stück
31972	starre Befestigung, M8x20	schwarz	4,95 / Stück
31973	starre Befestigung, M8x20	chrom seidenmatt	6,60 / Stück
31977	Verlängerung 25 mm	chrom	3,30 / Stück
31978	Verlängerung 25 mm	schwarz	3,00 / Stück
31979	Verlängerung 25 mm	chrom seidenmatt	3,30 / Stück
31980	Verlängerung 40 mm	chrom	4,45 / Stück
31981	Verlängerung 40 mm	schwarz	3,50 / Stück
31982	Verlängerung 40 mm	chrom seidenmatt (10)	4,45 / Stück
31936	Flexible Silentgummi-Befestigung 25 mm		5,95 / Stück
31935	Flexible Silentgummi-Befestigung 40 mm (9)		6,95 / Stück
31942	Leistungswiderstand 10 Ohm (für micro 1000)		3,95 / Stück
31945	Leistungswiderstand 8,2 Ohm (für micro 1000 LED)		4,95 / Stück
82063	Leistungsunabhängiger Blinkgeber 12V, 3-polig		14,95 / Stück

Kellermann

NEU!

BL 1000 white SG

Vorderer und hinterer Fahrtrichtungsanzeiger, ECE-geprüft

Der BL 1000 white SG ist die neue „Single Glass“ Variante des bekannten Lenkerendenblinkers und wird an den originalen Befestigungspunkten Ihres Motorrads befestigt. Die xenon-blauen Reflektionen der neuen Kellermann Klarglasoptik machen dieses Produkt zu einem attraktiven Blickfang. Dabei ermöglicht seine ECE-Zulassung als vorderer und hinterer Blinker die komplette Umrüstung Ihres Motorrads. Die originale Blinkfrequenz bleibt dabei erhalten (21 W). Das Metallgehäuse dient als Basis für verschiedene hochwertige Oberflächen. Umfangreiche Schutzrechte auf Design und Funktion! Made in Germany!

Best.Nr.: Blinker BL 1000 white SG	Preis in €
319020 chrom (1)	59,95 / Stück
319021 schwarz (2)	59,95 / Stück
319022 chrom seidenmatt (3)	59,95 / Stück
319023 Aluminium, poliert	59,95 / Stück

1

2

3

NEU!

BL 1000 white

Vorderer Fahrtrichtungsanzeiger, ECE-geprüft

Der BL 1000 white baut auf der bewährten Technik des BL 1000 auf und verbindet die klassische Eleganz mit innovativer moderner Klarglasoptik und hoher Qualität. Die Präzisionsoptik des BL 1000 white bietet mit ihrer xenon-blauen Reflektion eine neue attraktive Möglichkeit, sein Fahrzeug individuell umzugestalten. Wie üblich ist der BL 1000 white mit allen Adaptern zum Anbau an alle gängigen Rohrlenker ausgestattet und als vorderer Fahrtrichtungsanzeiger ECE-geprüft. Umfangreiche Schutzrechte auf Design und Funktion!

Best.Nr.: Blinker BL 1000 white	Preis in €
319024 Aluminium, seidenmatt geschliffen	69,95 / Stück
319025 Aluminium, schwarz pulverbeschichtet (5)	69,95 / Stück
319026 Aluminium, poliert	74,95 / Stück
319027 Aluminium, chrom seidenmatt (4)	79,95 / Stück
319028 Messing, schwarz pulverbeschichtet (2)	79,95 / Stück
319029 Messing, chrom seidenmatt (4)	89,95 / Stück
319030 Messing, chrom hochglänzend (7)	89,95 / Stück
319031 Edelstahl, seidenmatt geschliffen (8)	86,95 / Stück
319032 Edelstahl, poliert	89,95 / Stück

Die Austauschgrundkörper des BL 1000 white können auch für den BL 1000 mit gelbem Glas verwendet und mit wenig Aufwand ausgetauscht werden.

Best.Nr.: Austauschgrundkörper BL 1000 white	Preis in €
319033 Aluminium, seidenmatt geschliffen	35,50 / Stück
319034 Aluminium, schwarz pulverbeschichtet	35,50 / Stück
319035 Aluminium, poliert	38,00 / Stück
319036 Aluminium, chrom seidenmatt	42,00 / Stück
319037 Messing, schwarz pulverbeschichtet	42,00 / Stück
319038 Messing, chrom seidenmatt	47,80 / Stück
319039 Messing, chrom hochglänzend	47,80 / Stück
319040 Edelstahl, seidenmatt geschliffen	45,00 / Stück
319041 Edelstahl, poliert	49,90 / Stück

4

5

6

7

8



NEU!

KH 1000 Kennzeichen- und Blinkerhalter



Das KH 1000 Heckumbaukonzept ist durch seinen modularen Aufbau die ideale Komponente für den individuellen Umbau ihres Motorrads. Dieser Halter verbindet die exklusive Optik mit einer filigranen, belastungsgerechten Leichtbauweise. Die aus hochwertigen Aluminiumlegierungen hergestellten Halter sind für alle Micro 1000 Varianten geeignet und führen häufig zu einer nicht unerheblichen Gewichtsersparnis.

Die ansprechende Optik des KH 1000 Halters wird durch die formschöne, zugelassene Kennzeichenleuchte nochmals unterstrichen.

Durch den modularen Aufbau besteht die Möglichkeit, den Halter mit Hilfe der aufgeführten Fahrzeugadapter und der micro 1000 Varianten individuell zu kombinieren.

Best.-Nr.	KH 1000	Ausführung	Preis in €	
319500	KH 1000 (mit Blinkerhalter) (1)	silber	79,95 / Stück	
319600	KH 1000 (mit Blinkerhalter)	schwarz	79,95 / Stück	
319501	KH 1000 (ohne Blinkerhalter) (2)	silber	69,95 / Stück	
319601	KH 1000 (ohne Blinkerhalter)	schwarz	69,95 / Stück	
Best.-Nr.	Erstzteile KH 1000	Preis in €		
319502	Kennzeichenbeleuchtung	9,95 / Stück		
319503	Reflektor	3,95 / Stück		
319504	Reflektorträger	9,95 / Stück		
319505	Kennzeichenleuchte W5W	0,85 / Stück		
Fahrzeugadapter	Baujahr	Best.Nr. silber	Best.Nr. schwarz	Preis in €
BMW				
R1100S (3)	1998-2005	319510	319610	59,95 / Stück
Honda				
CBR 900 RR	2002-2003	319524	319624	59,95 / Stück
CBR 1000 RR	2004-2005	319520	319620	59,95 / Stück
CBR 600 RR	2005	319521	319621	59,95 / Stück
Hornet CB 900 F	2002-2005	319522	319622	59,95 / Stück
VFR 800 V-Tec	2002-2005	319523	319623	39,95 / Stück
KTM				
990 Superduke*	2005	319550	319650	69,95 / Stück
Suzuki				
GSX R 1000 (4)	2003-2004	319560	319660	39,95 / Stück
GSX R 600 / 750	2005	319561	319661	59,95 / Stück
SV 1000 (5)	2003-2005	319563	319663	59,95 / Stück
SV 650 (5)	2003-2005	319565	319665	59,95 / Stück
Triumph				
Speed Triple	2005	319570	319670	39,95 / Stück
Yamaha				
R1	2002-2003	319580	319680	39,95 / Stück
R1	2004-2005	319581	319681	39,95 / Stück
R6	2001-2002	319582	319682	39,95 / Stück
R6	2003-2005	319583	319683	39,95 / Stück
FZ6 Fazer	2004-2005	319585	319685	59,95 / Stück

Weitere Modelle folgen



BELEUCHTUNG, STURZTEILE

Blinker • Indicators • Clignotants

Bestell-Nr. 31 101

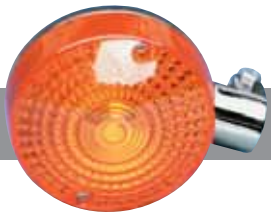

Bestell-Nr. 31 102

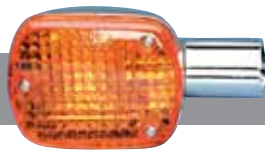

Bestell-Nr. 31 103

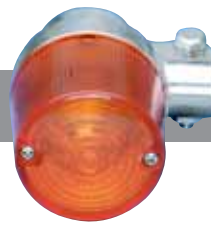

Bestell-Nr. 31 104



Bestell-Nr. 31 106



Bestell-Nr. 31 107
Bestell-Nr. 31 108



Bestell-Nr. 31 109



Bestell-Nr. 31 110



Bestell-Nr. 31 111
Bestell-Nr. 31 112



Bestell-Nr. 31 113
Bestell-Nr. 31 114



Bestell-Nr. 31 115
Bestell-Nr. 31 116



Bestell-Nr. 31 200
Bestell-Nr. 31 201



Bestell-Nr. 31 203
Bestell-Nr. 31 204

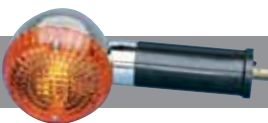

Bestell-Nr. 31 205



Bestell-Nr. 31 206



Bestell-Nr. 31 207



Bestell-Nr. 31 208



Bestell-Nr. 31 209



Bestell-Nr. 31 210



Bestell-Nr. 31 211



Fahrzeugtyp/ Bestell-Nr.	€
Honda	
31101	15,30
31102	19,60
31103	18,90
31104	16,00
31106	20,10
31107	22,50
31108	22,50
31109	22,50
31110	22,50
31111	17,90
31112	17,90

Fahrzeugtyp/ Bestell-Nr.	€
31113	17,90
31114	17,90
31115	22,50
31116	22,50

Fahrzeugtyp/ Bestell-Nr.	€
Kawasaki	
31200	16,90
31201	16,90
31203	24,90
31204	24,90
31205	22,90
31206	22,90
31207	20,10
31208	22,90
31209	21,20
31210	18,90
31211	18,90

BELEUCHTUNG, STURZTEILE

Blinker • Indicators • Clignotants

Bestell-Nr. 31 300
Bestell-Nr. 31 301

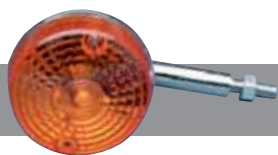

Bestell-Nr. 31 302

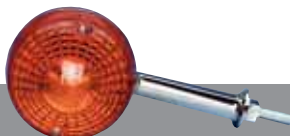

Bestell-Nr. 31 303
Bestell-Nr. 31 304



Bestell-Nr. 31 305



Bestell-Nr. 31 306



Bestell-Nr. 31 307



Bestell-Nr. 31 308



Bestell-Nr. 31 309
Bestell-Nr. 31 310



Bestell-Nr. 31 311
Bestell-Nr. 31 312



Bestell-Nr. 31 400



Bestell-Nr. 31 401



Bestell-Nr. 31 402



Bestell-Nr. 31 403
Bestell-Nr. 31 404



Bestell-Nr. 31 405

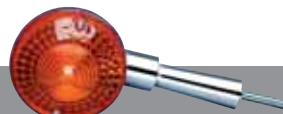

Bestell-Nr. 31 406

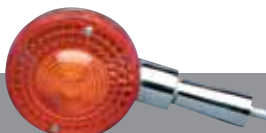

Bestell-Nr. 31 407
Bestell-Nr. 31 408



Bestell-Nr. 31 409



Bestell-Nr. 31 410



Bestell-Nr. 31 411



Bestell-Nr. 31 412



Fahrzeugtyp/ Bestell-Nr.	€
Suzuki	
31300	18,90
31301	18,90
31302	25,60
31303	23,70
31304	23,70
31305	22,90
31306	20,00
31307	18,80
31308	18,90
31309	22,50
31310	22,50
31311	22,50
31312	22,50

Fahrzeugtyp/ Bestell-Nr.	€
Yamaha	
31400	16,90
31401	17,40
31402	14,90
31403	14,90
31404	16,00
31405	19,60
31406	19,60
31407	17,40
31408	16,80
31409	19,60
31410	22,90
31411	20,10
31412	22,00

Alle Preise sind unverbindliche Preisempfehlung inkl. MwSt.

www.cypacc.de

195

SCOOTER

BELEUCHTUNG, STURZTEILE

Blinker • Indicators • Clignotants

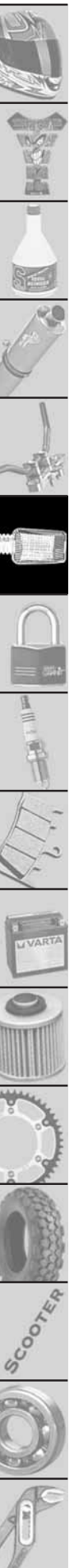

Bestell-Nr.	TYP	Baujahr	Position
HONDA			
31 104	Z 50 G	79	vorne/hinten
31 104	Z 50 J	79-85	vorne/hinten
31 104	XL 50	77-	vorne/hinten
31 104	CY 50	78	vorne/hinten
31 104	CB 50 J	77-84	vorne/hinten
31 103	ST 50	72-	vorne/hinten
31 103	ST 50 K3	77-80	vorne/hinten
31 103	ST 70 K3	73	vorne/hinten
31 104	CY 80	79	vorne/hinten
31 103	CB 100		vorne/hinten
31 102	CA 125	95-97	vorne/hinten
31 103	CB 125 J	75-81	vorne/hinten
31 103	CB 125 K1-K5	71-76	vorne/hinten
31 103	CB 125 B6	75-81	vorne/hinten
31 104	CB 125 T	79-80	vorne/hinten
31 103	CB 125 T	80-82	vorne/hinten
31 103	SL 125	76	vorne/hinten
31 103	TL 125 S	76-78	vorne/hinten
31 103	XL 125	76-78	vorne/hinten
31 104	CM 125 C	82-	vorne/hinten
31 104	CM 185 T	79-	vorne/hinten
31 103	CB 200	76-81	vorne/hinten
31 103	CB 250 K3-K5	73-75	vorne/hinten
31 103	CB 250 G	73	vorne/hinten
31 113	CB 250 N	78-83	vorne links
31 114	CB 250 N	78-84	vorne rechts
31 111	CB 250 N	78-85	hinten links
31 112	CB 250 N	78-86	hinten rechts
31 104	CB 250 T	78	vorne/hinten
31 104	CJ 250 T	79	vorne/hinten
31 103	CL 250 K	81	vorne/hinten
31 104	CL 250 S	82	vorne/hinten
31 102	CMX 250 C	96-	vorne/hinten
31 103	XL 250 K3-K4	73-74	vorne/hinten
31 103	CB 350	73-	vorne/hinten
31 103	CB 360 G	74-	vorne/hinten
31 104	CJ 360 T	76	vorne/hinten
31 104	CB 400 A	77-81	vorne/hinten
31 103	CB 400 F	75-	vorne/hinten
31 109	CB 400 F	91	vorne links
31 110	CB 400 F	91	vorne rechts
31 110	CB 400 F	91	hinten links
31 109	CB 400 F	91	hinten rechts
31 113	CB 400 N	78-83	vorne links
31 114	CB 400 N	78-83	vorne rechts
31 111	CB 400 N	78-83	hinten links
31 112	CB 400 N	78-83	hinten rechts
31 104	CB 400 T	79-81	vorne/hinten
31 104	CM 400 T	80-82	vorne/hinten
31 109	NSR 400	85-	vorne links
31 110	NSR 400	85-	vorne rechts
31 110	NSR 400	85-	hinten links
31 109	NSR 400	85-	hinten rechts
31 109	VFR 400 R	90-91	vorne links
31 110	VFR 400 R	90-91	vorne rechts
31 110	VFR 400 R	90-91	hinten links
31 109	VFR 400 R	90-91	hinten rechts
31 103	CB 450 K1-K5	71-75	vorne/hinten

Bestell-Nr.	TYP	Baujahr	Position
31 113	CB 450 N	85	vorne links
31 114	CB 450 N	85	vorne rechts
31 109	CB 450 S	86-90	vorne links
31 110	CB 450 S	86-90	vorne rechts
31 110	CB 450 S	86-90	hinten links
31 109	CB 450 S	86-90	hinten rechts
31 103	CL 450	74-76	vorne/hinten
31 103	CB 500 F	72-	vorne/hinten
31 103	CB 500 K	72-	vorne/hinten
31 103	CB 500 T	75-	vorne/hinten
31 103	CX 500	79-82	vorne/hinten
31 101	CX 500 C	80-82	vorne/hinten
31 107	GB 500 Clubman	89-90	vorne/links
31 108	GB 500 Clubman	89-90	vorne/rechts
31 108	GB 500 Clubman	89-90	hinten/links
31 107	GB 500 Clubman	89-90	hinten/rechts
31 109	VF 500 F	84-85	vorne links
31 110	VF 500 F	84-85	vorne rechts
31 110	VF 500 F	84-85	hinten links
31 109	VF 500 F	84-85	hinten rechts
31 109	VT 500 E	83-85	vorne links
31 110	VT 500 E	83-85	vorne rechts
31 110	VT 500 E	83-85	hinten links
31 109	VT 500 E	83-85	hinten rechts
31 102	VT 500 C	83	vorne/hinten
31 109	XBR 500 S	85-89	vorne links
31 110	XBR 500 S	85-89	vorne rechts
31 110	XBR 500 S	85-89	hinten links
31 109	XBR 500 S	85-89	hinten rechts
31 103	CB 550 F	75-76	vorne/hinten
31 101	CB 550 K	76	vorne/hinten
31 106	CBX 550	82	vorne/hinten
31 109	CBR 600 F	95-97	vorne links
31 110	CBR 600 F	95-97	vorne rechts
31 115	CBR 600 F	97-98	vorne links
31 116	CBR 600 F	97-98	vorne rechts
31 115	CBR 600 F	97-98	hinten links
31 116	CBR 600 F	97-98	hinten rechts
31 107	VT 600 C	88-97	vorne links
31 108	VT 600 C	88-97	vorne rechts
31 108	VT 600 C	88-97	hinten links
31 107	VT 600 C	88-97	hinten rechts
31 101	CB 650 C	80-81	vorne/hinten
31 101	CB 650 SC	82	vorne/hinten
31 102	CBX 650 E	83-	vorne/hinten
31 102	CX 650 C	83	vorne/hinten
31 109	NT 650	88-97	vorne links
31 110	NT 650	88-97	vorne rechts
31 110	NT 650	88-97	hinten links
31 109	NT 650	88-97	hinten rechts
31 109	NTV 650	88-97	vorne links
31 110	NTV 650	88-97	vorne rechts
31 110	NTV 650	88-97	hinten links
31 109	NTV 650	88-97	hinten rechts
31 101	CB 750 C	81	vorne/hinten
31 101	CB 750 F1,F2	77-78	vorne/hinten
31 101	CB 750 K 7	76	vorne/hinten
31 103	CB 750 K0-K6	71-75	vorne/hinten
31 102	CB 750 Seven Fifty	91-98	vorne/hinten

BELEUCHTUNG, STURZTEILE

Blinker • Indicators • Clignotants

Bestell-Nr.	TYP	Baujahr	Position
31 109	CBX 750 F	84-86	vorne links
31 110	CBX 750 F	84-86	vorne rechts
31 110	CBX 750 F	84-86	hinten links
31 109	CBX 750 F	84-86	hinten rechts
31 109	RVF 750 R	94-97	vorne links
31 110	RVF 750 R	94-97	vorne rechts
31 102	VF 750 C	82-84	vorne/hinten
31 107	VF 750 C	93-97	vorne links
31 108	VF 750 C	93-97	vorne rechts
31 108	VF 750 C	93-97	hinten links
31 107	VF 750 C	93-97	hinten rechts
31 109	VF 750 F	82-84	vorne links
31 110	VF 750 F	82-84	vorne rechts
31 110	VF 750 F	82-84	hinten links
31 109	VF 750 F	82-84	hinten rechts
31 106	VF 750 S	82-84	vorne/hinten
31 109	VFR 750	88-91	vorne links
31 110	VFR 750	88-91	vorne rechts
31 110	VFR 750	88-91	hinten links
31 109	VFR 750	88-91	hinten rechts
31 107	VT 750 C	87	vorne links
31 108	VT 750 C	87	vorne rechts
31 108	VT 750 C	87	hinten links
31 107	VT 750 C	87	hinten rechts
31 109	CBR 900 RR	92-95	vorne links
31 110	CBR 900 RR	92-95	vorne rechts
31 110	CBR 900 RR	92-95	hinten links
31 109	CBR 900 RR	92-95	hinten rechts
31 115	CBR 900 RR	96-98	vorne links
31 116	CBR 900 RR	96-98	vorne rechts
31 115	CBR 900 RR	96-98	hinten rechts
31 116	CBR 900 RR	96-98	hinten links
31 106	CB 1000 F	93-96	vorne/hinten
31 101	GL 1000	75-	vorne/hinten
31 109	VF 1000 F,F2,R	84-86	vorne links
31 110	VF 1000 F,F2,R	84-86	vorne rechts
31 110	VF 1000 F,F2,R	84-86	hinten links
31 109	VF 1000 F,F2,R	84-86	hinten rechts
31 115	VTR 1000	97	vorne links
31 116	VTR 1000	97	vorne rechts
31 115	VTR 1000	97	hinten rechts
31 116	VTR 1000	97	hinten links
31 102	VF 1100 C	83	vorne/hinten
31 107	VT 1100 C	88-97	vorne links
31 108	VT 1100 C	88-97	vorne rechts
31 108	VT 1100 C	88-97	hinten rechts
31 107	VT 1100 C	88-97	hinten links

KAWASAKI

31 200	KMX 200	88-91	vorne/hinten
31 201	KLR 250	85-92	vorne/hinten
31 201	KLX 250	93-94	vorne/hinten
31 203	EL 250	88-97	vorne lang
31 204	EL 250	88-97	hinten kurz
31 203	BJ 250	94-97	vorne lang
31 207	GPZ 400	85	vorne
31 209	Z 400	77-79	vorne/hinten
31 209	Z 440	80-83	vorne/hinten
31 204	BJ 250	94-97	hinten kurz

Bestell-Nr.	TYP	Baujahr	Position
31 208	EN 500		vorne/hinten
31 207	GPZ 500 A	84-89	vorne
31 211	GPZ 500 S	94-97	vorne lang
31 210	GPZ 500 S	94-97	hinten kurz
31 211	KLE 500	91-96	vorne/hinten
31 207	GPZ 550	84-89	vorne
31 204	EN 500	90-97	hinten kurz
31 203	ZR 550 Zephyr	91-97	vorne lang
31 204	ZR 550 Zephyr	91-97	hinten kurz
31 201	KLR 600	84-89	vorne
31 200	KLR 600	84-89	hinten
31 205	GPZ 600 R	85-89	vorne lang
31 206	GPZ 600 R	85-89	hinten kurz
31 208	ZL 600		vorne/hinten
31 210	ZX-6R	95-	vorne lang
31 211	ZX-6R	95-	hinten kurz
31 201	KLR 650	87-97	vorne
31 200	KLR 650	87-97	hinten
31 201	KLX 650	93-94	vorne/hinten
31 209	Z 650	77-79	vorne/hinten
31 207	GPZ 750	83-84	vorne
31 205	GPZ 750	85-86	vorne
31 206	GPX 750	87-88	vorne lang
31 205	GPX 750	87-88	hinten kurz
31 210	ZRX 750	89-95	vorne lang
31 211	ZRX 750	89-95	hinten kurz
31 203	ZR 750 Zephyr	91-96	vorne lang
31 204	ZR 750 Zephyr	91-96	hinten kurz
31 210	ZXR 750	89-95	vorne lang
31 211	ZXR 750	89-95	hinten kurz
31 207	ZX 750 Turbo	84-85	vorne
31 210	ZX 7 RR	96-	vorne lang
31 211	ZX 7 RR	96-	hinten kurz
31 209	Z 750	76-78	vorne/hinten
31 203	VN 800	95-97	vorne lang
31 204	VN 800	95-97	hinten kurz
31 206	GPZ 900 R	84-93	vorne lang
31 205	GPZ 900 R	84-93	hinten kurz
31 209	Z1 (900)	73-75	vorne/hinten
31 209	Z 900	76	vorne/hinten
31 210	ZX-9R	94-	vorne lang
31 211	ZX-9R	94-	hinten kurz
31 209	Z 1000	77-78	vorne/hinten
31 208	ZL1000		vorne/hinten
31 210	GTR 1000	86-96	hinten kurz
31 207	GPZ 1100	83-85	vorne
31 203	ZR 1100 Zephyr	92-97	vorne lang
31 208	VN 1500	88-97	vorne/hinten

SUZUKI

31 300	GT 50	77-81	vorne lang
31 301	GT 50	77-81	hinten kurz
31 300	RV 50	76-81	vorne lang
31 301	RV 50	76-81	hinten kurz
31 300	TS 50	79-81	vorne lang
31 301	TS 50	79-81	hinten kurz
31 300	GT 125	75-79	vorne lang
31 301	GT 125	75-79	hinten kurz
31 300	TS 125	74-81	vorne lang

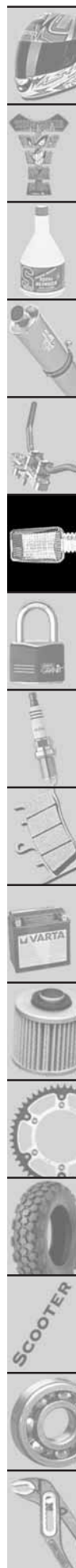

BELEUCHTUNG, STURZTEILE

Blinker • Indicators • Clignotants

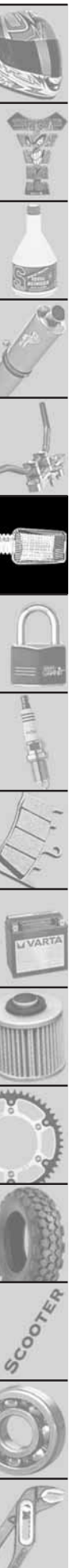

Bestell-Nr.	TYP	Baujahr	Position
31 301	TS 125	74-81	hinten kurz
31 300	GN 250	82-96	vorne lang
31 301	GN 250	82-96	hinten kurz
31 300	GT 250	78-79	vorne lang
31 301	GT 250	78-79	hinten kurz
31 306	RGV 250	89-93	vorne
31 307	RGV 250	89-93	hinten
31 300	TS 250	76-81	vorne lang
31 301	TS 250	76-81	hinten kurz
31 306	DR 350	90-96	vorne
31 307	DR 350	90-96	hinten
31 300	GN 400	80-81	vorne lang
31 301	GN 400	80-81	hinten kurz
31 300	GS 400	77-81	vorne lang
31 301	GS 400	77-81	hinten kurz
31 308	GSF 400 Bandit	91-	vorne/hinten
31 300	GS 450 L	80-87	vorne lang
31 301	GS 450 L	80-87	hinten kurz
31 300	GS 500 E	76-79	vorne lang
31 301	GS 500 E	76-79	hinten kurz
31 306	GS 500 E	89-96	vorne
31 307	GS 500 E	89-96	hinten
31 300	GS 550	78-82	vorne lang
31 301	GS 550	78-82	hinten kurz
31 303	GSX 550	83-87	kurz
31 306	GSF 600 Bandit	95-	vorne
31 307	GSF 600 Bandit	95-	hinten
31 306	GSX 600 F	88-97	vorne
31 307	GSX 600 F	88-97	hinten
31 309	GSX-R 600		vorne links
31 310	GSX-R 600		vorne rechts
31 311	GSX-R 600		hinten links
31 312	GSX-R 600		hinten rechts
31 307	RF 600	93-94	vorne/hinten
31 306	RF 600	95-96	vorne
31 307	RF 600	95-96	hinten
31 305	VS 600	95-97	vorne/hinten
31 306	DR 650	90-97	vorne
31 307	DR 650	90-97	hinten
31 305	LS 650	86-97	vorne/hinten
31 309	XF 650		vorne links
31 310	XF 650		vorne rechts
31 311	XF 650		hinten links
31 312	XF 650		hinten rechts
31 302	GS 750	77-82	vorne/hinten
31 302	GT 750	72-77	vorne/hinten
31 302	GSX 750 L	80-81	vorne/hinten
31 304	GSX 550	83-87	lang
31 303	GSX 750 E, ES	83-86	kurz
31 304	GSX 750 E, ES	83-86	lang
31 306	GSX 750 F	89-97	vorne/hinten
31 306	GSXR 750	88-90	vorne/hinten
31 307	GSXR 750	91	vorne/hinten
31 306	GSXR 750 W	92-95	vorne
31 307	GSXR 750 W	92-95	hinten
31 305	VS 750 GL	86-91	vorne/hinten
31 306	DR 800	91-96	vorne
31 307	DR 800	91-96	hinten
31 305	VS 800	92-97	vorne/hinten

Bestell-Nr.	TYP	Baujahr	Position
31 305	VX 800	90-97	vorne/hinten
31 305	VZ 800	91	vorne/hinten
31 302	GS 850 G	79-80	vorne/hinten
31 300	GS 850 GL	80-81	vorne lang
31 301	GS 850 GL	80-81	hinten kurz
31 307	RF 900 R	94-97	vorne/hinten
31 302	GS 1000	78-80	vorne/hinten
31 300	GS 1000 GL	81	vorne lang
31 301	GS 1000 GL	81	hinten kurz
31 309	TL 1000		vorne links
31 310	TL 1000		vorne rechts
31 311	TL 1000		hinten links
31 312	TL 1000		hinten rechts
31 303	GSX 1100 ES, EF	83-86	kurz
31 305	GSX 1100 G	91-96	vorne/hinten
31 306	GSXR 1100	89-93	vorne
31 307	GSXR 1100	89-93	hinten
31 306	GSXR 1100 W	93-97	vorne
31 307	GSXR 1100 W	93-97	hinten
31 306	GSF 1200 Bandit	96-98	vorne
31 307	GSF 1200 Bandit	96-98	hinten
31 305	VS 1400	87-97	vorne/hinten

YAMAHA

31 404	DT 50 R	89-97	vorne
31 403	DT 50 R	89-97	hinten
31 404	DT 50 MX	86-87	vorne
31 403	DT 50 MX	86-87	hinten
31 404	SG 50	84	vorne
31 403	SG 50	84	hinten
31 404	DT 80 LC	83-84	vorne
31 403	DT 80 LC	83-84	hinten
31 404	DT 80 LC 2	85-96	vorne
31 403	DT 80 LC 2	85-96	hinten
31 404	DT 80 MX	84	vorne
31 403	DT 80 MX	84	hinten
31 402	RD 80 LC	82	vorne/hinten
31 402	RD 80 LC 2	83-87	vorne/hinten
31 402	RX 80 SE	82	vorne/hinten
31 404	DT 125 LC	82	vorne
31 403	DT 125 LC	82	hinten
31 401	DT 125 R	91-96	vorne/hinten
31 402	DT 125 LC	82	vorne/hinten
31 407	TDR 125	93-97	vorne
31 408	TDR 125	93-97	hinten
31 410	XV 125	97	vorne/hinten
31 400	DT 175 MX	77-81	vorne/hinten
31 400	DT 250 MX	77-81	vorne/hinten
31 405	RD 250	73-79	vorne
31 406	RD 250	73-79	hinten
31 402	RD 250 LC	82-82	vorne/hinten
31 402	SR 250 SE	80-83	vorne/hinten
31 401	TDR 250	88-90	vorne/hinten
31 407	TZR 250	87-90	vorne/hinten
31 405	XS 250	77-80	vorne
31 406	XS 250	77-80	hinten
31 400	XT 250	80-90	vorne/hinten
31 410	XV 250	89-97	vorne/hinten
31 405	RD 350	73-75	vorne

BELEUCHTUNG, STURZTEILE

Blinker • Indicators • Clignotants

Bestell-Nr.	TYP	Baujahr	Position
31 406	RD 350	73-75	hinten
31 402	RD 350 LC	80-84	vorne/hinten
31 404	RD 350 LC	85	vorne
31 403	RD 350 LC	85	hinten
31 407	RD 350 LC	86-88	vorne
31 408	RD 350 LC	86-88	hinten
31 404	XT 350	85-95	vorne
31 403	XT 350	85-95	hinten
31 405	XS 360	77	vorne
31 406	XS 360	77	hinten
31 400	DT 400	75-76	vorne/hinten
31 400	DT 400 MX	77-79	vorne/hinten
31 405	RD 400	76-79	vorne
31 406	RD 400	76-79	hinten
31 405	XS 400	78-82	vorne
31 406	XS 400	78-82	hinten
31 404	RD 500 LC	84-85	vorne
31 403	RD 500 LC	84-85	hinten
31 405	SR 500	78-83	vorne
31 406	SR 500	78-83	hinten
31 409	SR 500	84-97	vorne/hinten
31 400	XT 500	77-90	vorne/hinten
31 409	XV 500 SE	83	vorne/hinten
31 409	XV 535	87-88	vorne/hinten
31 410	XV 535	89-97	vorne/hinten
31 404	XT 550	82-83	vorne
31 403	XT 550	82-83	hinten
31 407	FZR 600	89-93	vorne
31 408	FZR 600	89-93	hinten
31 411	FZR 600 R	94-	vorne
31 412	FZR 600 R	94-	hinten
31 411	FZS 600 Fazer	98-	vorne
31 412	FZS 600 Fazer	98-	hinten
31 407	SRX 600	86-90	vorne
31 408	SRX 600	86-90	hinten
31 407	XJ 600 N	86-97	vorne
31 408	XJ 600 N	86-97	hinten
31 408	XJ 600 S	92-97	vorne
31 407	XJ 600 S	92-97	hinten
31 404	XT 600	84-86	vorne
31 403	XT 600	84-86	hinten
31 401	XT 600	87-95	vorne/hinten
31 404	XT 600 Z	83-84	vorne
31 403	XT 600 Z	83-84	hinten
31 404	XT 600 Z Tenere	85-86	vorne
31 403	XT 600 Z Tenere	85-86	hinten
31 401	XT 600 Z Tenere	87-90	vorne/hinten
31 411	YZF 600 R	96-	vorne
31 412	YZF 600 R	96-	hinten
31 411	YZF R6	99-	vorne
31 412	YZF R6	99-	hinten
31 405	XJ 650	80-81	vorne
31 406	XJ 650	80-81	hinten
31 409	XJ 650	82-83	vorne/hinten
31 405	XS 650	75-81	vorne
31 406	XS 650	75-81	hinten
31 410	XVS 650	97	vorne/hinten
31 401	XIZ 660	91-95	vorne/hinten
31 404	FZ 750	85	vorne

Bestell-Nr.	TYP	Baujahr	Position
31 403	FZ 750	85	hinten
31 407	FZ 750 Genesis	86-94	vorne
31 408	FZ 750 Genesis	86-84	hinten
31 407	FZR 750 R	89	vorne
31 408	FZR 750 R	89	hinten
31 407	FZX 750 Fazer	87-88	vorne
31 408	FZX 750 Fazer	87-88	hinten
31 405	XS 750	77-80	vorne
31 406	XS 750	77-80	hinten
31 401	XTZ 750	89-96	vorne/hinten
31 401	XTX 750	90	vorne/hinten
31 409	XV 750 SE	81-82	vorne/hinten
31 410	XV 750	92-97	vorne/hinten
31 411	YZF 750 R	93-	vorne
31 412	YZF 750 R	93-	hinten
31 411	YZF R7	99-	vorne
31 412	YZF R7	99-	hinten
31 407	TDM 850	91-97	vorne
31 408	TDM 850	91-97	hinten
31 411	TRX 850	96-	vorne
31 412	TRX 850	96-	hinten
31 405	XS 850	80	vorne
31 406	XS 850	80	hinten
31 407	XJ 900 S Diversion	95-97	vorne
31 408	XJ 900 S Diversion	95-97	hinten
31 407	FZR 1000	87-95	vorne
31 408	FZR 1000	87-95	hinten
31 409	XV 1000	81-83	vorne/hinten
31 410	XV 1000	86-91	vorne/hinten
31 411	YZF 1000 R	96-	vorne
31 412	YZF 1000 R	96-	hinten
31 411	YZF R1	98-	vorne
31 412	YZF R1	98-	hinten
31 409	XS 1100 S	81	vorne/hinten
31 410	XV 1100 Virago	89-97	vorne/hinten
31 407	FJ 1200	86-92	kurz
31 408	FJ 1200	86-92	lang
31 410	VMX 1200 V-Max	85-97	vorne/hinten
31 410	XVZ 1300	96-97	vorne/hinten

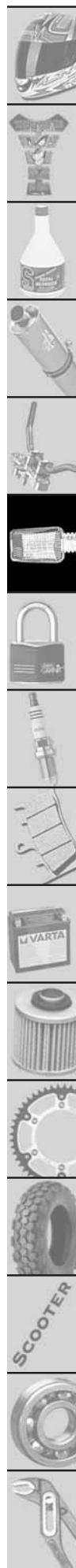

BELEUCHTUNG, STURZTEILE

Rückleuchten • Taillights • Feux Arrière

Bestell-Nr.	Rücklichter mit Nummernschildbeleuchtung	€
31 001	Cat-Eye verchromt, Metallgehäuse	23,95
31 007	Cat-Eye verchromt, LED -Technik, Metallgehäuse	39,95
31 002	Cat-Eye verchromt, Kunststoffgehäuse	18,95



Bestell-Nr. 31 001-002



LED!

Bestell-Nr. 31 007

Bestell-Nr.	Rücklichter mit Nummernschildbeleuchtung	€
31 003	Rücklicht Mini	7,95
31 004	Rücklicht Mini-Doppel incl. Halteplatte	34,95
31 005	Shin-Yo Minirücklicht chrom	13,95
31 006	Shin-Yo Minirücklicht schwarz	12,95
31 008	Mini-Rücklicht rund chrom	9,95
31 009	Mini-Rücklicht rund schwarz	8,95
31 023	LED - Rücklicht Mini rund	24,95
31 022	LED -Mini-Rücklicht - Sharknose Ø 42mm	32,95
31 026	LED -Mini-Rücklicht weiss - Sharknose Ø 42mm	32,95



Bestell-Nr. 31 004



Bestell-Nr. 31 003



Bestell-Nr. 31 005



Bestell-Nr. 31 006



LED!

Bestell-Nr. 31 023



Bestell-Nr. 31 022



LED!

Bestell-Nr. 31 026



Bestell-Nr. 31 008-31 009

Bestell-Nr.	Doppel-LED-Rücklicht	€
31 016	verchromt	54,95



Bestell-Nr. 31 013-31014



LED!

Bestell-Nr. 31 016



Bestell-Nr. 31 027-31 028

LED!



Bestell-Nr. 31 055



LED!

Bestell-Nr. 31 892

Bestell-Nr.	Cat's Eye	€
31 013	Mini chrom	19,95
31 014	Micro chrom	16,95
31 027	Mini schwarz	19,95
31 028	Micro schwarz	16,95

Bestell-Nr.	Nummernschildbeleuchtung	€
31 892	Nummernschildbeleuchtung und Positionsluchte, E-geprüft	14,95
31 055	LED Nummernschildbeleuchtung universell einsetzbar, z.B. für Instrumentenbeleuchtung, Minimaler Stromverbrauch, federleicht, effizient. Nicht E-geprüft, leuchtet weiss.	9,95

Alle Rückleuchten sind für Stand- und Bremslicht vorgesehen und mit "E" Prüfzeichen. Passende Glühlampen finden Sie in diesem Katalog unter Glühlampen.

BELEUCHTUNG, STURZTEILE

Rückleuchten • Taillights • Feux Arrière

Bestell-Nr.	Rücklichter mit Nummernschildbeleuchtung	€
31 010	Edel-Cat-Eye verchromt mit Halterung	69,95



Bestell-Nr. 31 010

Bestell-Nr.	Rücklichter	€
31 011	Mini-Cat-Eye schmal mit Halteplatte	42,95
31 012	Mini-Cat-Eye schmal ohne Halteplatte	29,95



Bestell-Nr. 31 011



Bestell-Nr. 31 012



Bestell-Nr. 31 017

LED!

Bestell-Nr.	Rücklichter	€
31 017	Cat-Eye-LED-Rücklicht	39,95
31 018	Cat-Eye-LED-Rücklicht mit Halterung	44,95



Bestell-Nr. 31 018

Bestell-Nr.	Shin-Yo LED-Rücklicht	€
31 029	Glas weiß, leuchtet unter Spannung rot, sehr geringer Stromverbrauch, mit Nummernschildbeleuchtung 11x2,5 cm	26,95
31 057	Glas rot, leuchtet unter Spannung, sehr geringer Stromverbrauch, mit Nummernschildbeleuchtung 11x2,5 cm	26,95



Bestell-Nr. 31 057



Bestell-Nr. 31 029

Bestell-Nr.	LED-Rücklicht Monster Style	€
31 019		49,95



LED!



Bestell-Nr. 31 021

Bestell-Nr.	Doppel-Mini-Rücklichter L.A.	€
31 020	ohne Halteplatte verchromt	29,95
31 021	mit Halteplatte verchromt	39,95



Bestell-Nr. 31 020

Bestell-Nr.	Rückstrahler	€
31 700	70x30mm Hella zum Kleben	2,90
31 701	94x44mm Hella zum Kleben	2,70
31 702	94x44mm Hella zum Schrauben	2,50

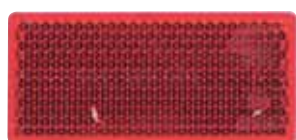

Bestell-Nr. 31 700

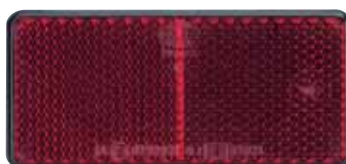

Bestell-Nr. 31 701



Bestell-Nr. 31 702

Alle Rückleuchten sind für Stand- und Bremslicht vorgesehen und mit "E" Prüfzeichen. Passende Glühlampen finden Sie in diesem Katalog unter Glühlampen.

Klarglasrückleuchten in Originalform, E-geprüft

Es werden keine gefärbten Birnen benötigt, da im Rücklicht eine rote Kappe über den Birnen ist. Die LED´s leuchten rot.

HONDA

Bestell-Nr.		€
31 030	Transparente Rückleuchte CBR600 F4 99-00	59,95
31 031	Transparente Rückleuchte CBR600 F4 01-02	59,95
31 032	Transparente Rückleuchte CBR900 RR 00-01	59,95
31 044	Transparente Rückleuchte VTR1000F 98-	59,95
31 041	Transparente Rückleuchte VTR1000SP1 RC51 00-01	59,95



Bestell-Nr. 31 030



Bestell-Nr. 31 031



Bestell-Nr. 31 032



Bestell-Nr. 31 041



Bestell-Nr. 31 044

KAWASAKI

Bestell-Nr.		€
31 036	Transparente Rückleuchte ZX12-R 00-02	59,95
31 037	Transparente Rückleuchte ZRX1100/1200 97	59,95
31 042	Transparente Rückleuchte ZX6-R/ZX9-R	59,95
31 045	Transparente LED-Rückleuchte ZX6-R/ZX9-R	59,95
31 039	Transparente Rückleuchte ER 5	59,95



Bestell-Nr. 31 036



Bestell-Nr. 31 037



Bestell-Nr. 31 042



Bestell-Nr. 31 039



Bestell-Nr. 31 045

LED STUFF!

Alle Rückleuchten sind für Stand- und Bremslicht vorgesehen und mit "E" Prüfzeichen.
Passende Glühlampen finden Sie in diesem Katalog unter Glühlampen.

SUZUKI

Bestell-Nr.		€
31 046	Transparente Rückleuchte GSF600 Bandit 95-00	59,95
31 047	Transparente Rückleuchte GSX-R600/750 SRAD 96-00 (ohne Abb.)	59,95
31 034	Transparente Rückleuchte GSX-R600/750 00-03	59,95
31 034	Transparente Rückleuchte GSX-R1000 01-02	59,95
31 035	Transparente Rückleuchte GSX-R1300	59,95
31 038	Transparente Rückleuchte Suzuki SV 650 N/S 99-02	59,95
31 039	Transparente Rückleuchte GSX 750	59,95
31 038	Transparente Rückleuchte TL1000S 97-00	59,95
31 048	Transparente Rückleuchte GSF1200 Bandit 96-00 (ohne Abb.)	59,95



Bestell-Nr. 31 034



Bestell-Nr. 31 035



Bestell-Nr. 31 046



Bestell-Nr. 31 038



Bestell-Nr. 31 039

YAMAHA

Bestell-Nr.		€
31043	Transparente Rückleuchte YZF-R6 98-00	59,95
31033	Transparente Rückleuchte YZF-R1 00-01	59,95
31040	Transparente Rückleuchte YZF-R1 98-99	59,95
31049	Transparente Rückleuchte XJR1300 99-	59,95
31050	Transparente LED-Rückleuchte R1 00-01	59,95



Bestell-Nr. 31 043



Bestell-Nr. 31 033



Bestell-Nr. 31 040



Bestell-Nr. 31 049



Bestell-Nr. 31 050

DUCATI

Bestell-Nr.		€
31019	Transparente LED Rückleuchte Monster -99	49,95



Bestell-Nr. 31 019

LED STUFF!

Alle Rückleuchten sind für Stand- und Bremslicht vorgesehen und mit "E" Prüfzeichen.
Passende Glühlampen finden Sie in diesem Katalog unter Glühlampen.



Best.-Nr.	Typ	€
Bates Style		
72 004	verchromt 5 3/4" H4 Ø 155mm	49,95
mit Befestigung unten, konventionelle Streuscheibe		



Best.-Nr.	Typ	€
Fernscheinwerfer Bates Style		
72 025	verchromt 4 1/2" H4 Ø 123mm	59,95
mit Befestigung unten, blaues Glas, Prismenreflektor		

Best.-Nr.	Typ	€
Fernscheinwerfer Bates Style		
72 018	verchromt 5 3/4" H4 Ø 155mm	59,95
Befestigung seitlich, Prismenreflektor		
72 019	verchromt 5 3/4" H4 Ø 155mm	59,95
Befestigung unten, Prismenreflektor		



Best.-Nr.	Typ	€
Ovaler Doppelscheinwerfer		
Fern- und Nebelscheinwerfer, schw. Metallgehäuse, blaues Glas, Halter m. Langlöchern, 152x70x61mm		
72 012	schwarz E-geprüft, H3 12V55W	69,95

Best.-Nr.	Typ	€
Ovaler Doppelscheinwerfer		
Fern- und Nebelscheinwerfer, verchromt, weißes Glas, Halter m. Langlöchern, 152x70x61mm		
72 013	verchromt E-geprüft, H3 12V55W	129,95
Fern- und Nebelscheinwerfer, verchromt, blaues Glas, Halter m. Langlöchern, 152x70x61mm		
72 014	verchromt E-geprüft, H3 12V55W	129,95



Best.-Nr.	Typ	€
2 Scheinwerfer mit LED-Standlichtring		
72 015	Zusatzscheinwerfer, einzeln oder als Doppelscheinwerfer montierbar, Klarglasscheibe, Halterung Edelstahl mit Langlöchern	149,95

BELEUCHTUNG, STURZTEILE

Scheinwerfer • Headlights • Phares



Best.-Nr.	Typ	€
Double-Flash Doppelscheinwerfer		
72 098	schwarz 3 1/2" H7/H4 Abblend-, Fern- und Standlicht, E-geprüft (HC/HR)	Ø 90mm 109,95
72 099	verchromt 3 1/2" H7/H4 Abblend-, Fern- und Standlicht, E-geprüft (HC/HR)	Ø 90mm 99,95
72 100	verchromt 3 1/2" H4/H4 Fernlicht, E-geprüft (HR)	Ø 90mm 99,95
72 101	schwarz 3 1/2" H4/H4 Fernlicht, E-geprüft (HR)	Ø 90mm 109,95



Best.-Nr.	Typ	€
Single-Flash		
72 102	verchromt 3 1/2" H4 Fern- u. Nebelscheinwerfer 12V, 60/55W, Befestigung unten	Ø 90mm 69,95



Best.-Nr.	Typ	€
Kunststoff Einzelscheinwerfer 7"		
Universal. Extrem leicht. Made in Germany, m. seitlicher Befestigung, Ø 188mm, extrem leicht		
72 103	verchromt E-geprüft, H4 12V/60/55	64,95

Best.-Nr.	Typ	€
Quadro		
Ø		
72 110	verchromt H4 B:185,H:115,T:120 mit seitlicher Befestigung (o. Abbildung)	79,95
72 111	mit unterer Befestigung H4 B:185,H:115,T:120	79,95



Best.-Nr.	Typ		€
Scheinwerfereinsätze			
72 020	154mm mit Standlicht	H4	24,95
72 021	176mm 7" mit Standlicht	H4	24,95
72 022	5 3/4" mit Standlicht	H4	24,95



Best.-Nr.	Typ		€
Lampenhaltersatz			
		Ø	
72 050	verchromt, universal	30-38 mm	19,95
72 051	verchromt, universal	38-42 mm	29,95

Best.-Nr.	Typ		€
Lampenhaltersatz Deluxe			
72 231	2 Halter + 4 Schellen	31-34mm	49,95
72 235	2 Halter + 4 Schellen	35-38mm	49,95
72 239	2 Halter + 4 Schellen	39-42mm	49,95
72 243	2 Halter + 4 Schellen	43-46mm	49,95
72 247	2 Halter + 4 Schellen	47-50mm	49,95
72 251	2 Halter + 4 Schellen	51-54mm	49,95
72 255	2 Halter + 4 Schellen	55-58mm	49,95



Der LTD Scheinwerfer ist sehr universell als Hauptscheinwerfer einsetzbar, Durchmesser 193 mm, Tiefe 68 mm

Best.-Nr.	Typ		€
LTD-Scheinwerfer			
72 009	seitliche Befestigung, E-geprüft, 7", H4		56,95
	schwarzes Metallgehäuse		
72 026	seitliche Befestigung, E-geprüft, 7", H4		74,95
	schwarzes Metallgehäuse, Prismenreflektor		



Best.-Nr.	Typ		€
LTD-Scheinwerfer			
72 008	seitliche Befestigung, E-geprüft, 7", H4		59,95
	verchromtes Metallgehäuse		
72 027	seitliche Befestigung, E-geprüft, 7", H4		77,95
	verchromtes Metallgehäuse, Prismenreflektor		

Best.-Nr.	Typ	€
	Elipsoid Doppelscheinwerfer	
72 040	Abblend-, Stand-, Fernlicht H3 - 12V 55W Glühlampe, Linse D 64,5 mm, Tiefe ab Rahmen 86 mm, Gesamttiefe 151,4 mm	94,95



Fern- und Nebel-Zusatzscheinwerfer, E-geprüft, mit H3 12V 55W Glühlampe

Best.-Nr.	Typ	€
	Ovaler Fernscheinwerfer	
72 030	verchromtes Metallgehäuse	34,95



Best.-Nr.	Typ	€
	Ovaler Nebelscheinwerfer	
72 031	verchromtes Metallgehäuse	34,95



Best.-Nr.	Typ	€
	Ovaler Fernscheinwerfer	
72 032	verchromtes Metallgehäuse	34,95



Best.-Nr.	Typ	€
	Micro Nebelscheinwerfer	
72 033	Metallgehäuse	22,95

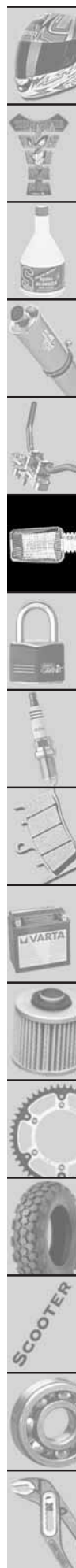



MotoVision



Sie fahren leidenschaftlich gerne Motorrad, doch durch die Zunahme des Straßenverkehrs wird dieses Vergnügen immer gefährlicher und unangenehmer.
Für Ihre Sicherheit ist es daher von größter Bedeutung, dass Sie von den anderen Verkehrsteilnehmern sofort gesehen werden.



*Besser gesehen werden!

Mit MotoVision-Lampen können Sie gesehen werden!

1. Besser gesehen werden durch helleres Licht mit orange-farbener Reflexion.
2. Sehen Sie einfach besser:
 - +40% mehr weißes Licht.
 - 10-20 Meter längerer Lichtkegel.

Alle MotoVision-Lampen entsprechen den europäischen Normen.

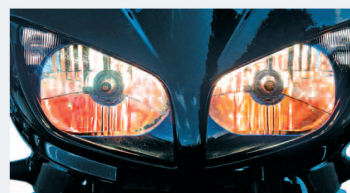
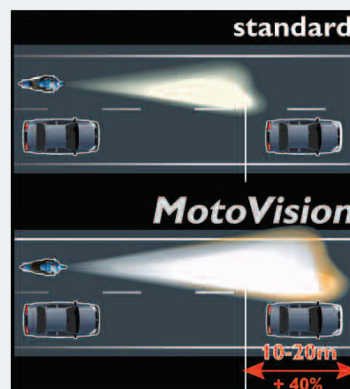

H4 Moto Vision

Bestell-Nr.	V	W	Socket	ECE	VPE	€
61700004	12	60/55	P43t-38	E1-2C3	10	14,99

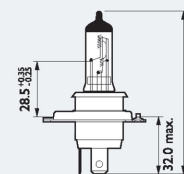
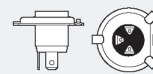

H7 Moto Vision

Bestell-Nr.	V	W	Socket	ECE	VPE	€
61700007	12	55	PX26d	E1-2Z2	10	19,99

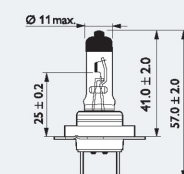
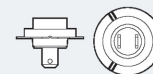



ExtraDuty 20g/10g



4x vibration resistant

Sie fahren Ihr Motorrad oder Ihren Motorroller vor allem im Stadtverkehr. Fahren auf Kopfsteinpflaster, Parken auf dem Bürgersteig, häufiges Beschleunigen und Bremsen bedeuten für Ihre Lampen Tag für Tag eine hohe Vibrationsbelastung. Diese Vibrationsbelastung zählt zu den häufigsten Gründen für den Ausfall der Lampen. Ihre Lebensdauer verkürzt sich, und sie müssen häufiger gewechselt werden.

Für dieses Problem hat Philips die Lampenreihe ExtraDuty entwickelt.

- Durch einen verstärkten Glühdraht halten diese Lampen Vibrationen bis zu 20 g Erdbeschleunigung aus und bieten daher eine längere Lebensdauer.



20g  

H4 ExtraDuty

Bestell-Nr. V W Sockel
61750004 12 60/55 P43t-38

ECE VPE €
E1-2C3 10 8,99

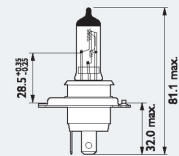
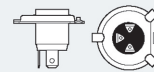

20g  

H7 ExtraDuty

Bestell-Nr. V W Sockel
61750007 12 55 PX26d

ECE VPE €
E1-22Z 10 15,99

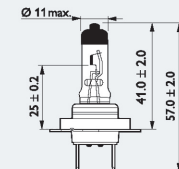
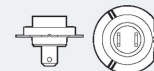

10g  

HS1 ExtraDuty

Bestell-Nr. V W Sockel
61750001 12 35/35 PX43t

ECE VPE €
E1-2E5 10 12,99

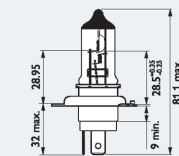
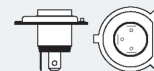

10g  

S2 ExtraDuty

Bestell-Nr. V W Sockel
61750002 12 35/35 BA20d

ECE VPE €
E1-2D1 10 6,99

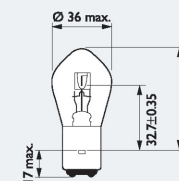

10g 

P21/5W ExtraDuty

Bestell-Nr. V W Sockel
61750000 12 21/5 BAY15d

ECE VPE €
E1-2CR 20 2,99

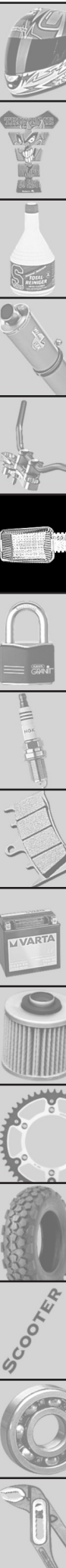
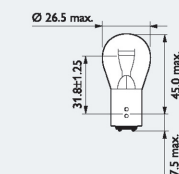

Scheinwerferbirnen

Volt	Watt	Socket	Typ	Bemerkung	Best.-Nr.	€/Stck.
6	15	P26S		mit Kragen (VPE 10)	61101	1,65
6	25/25	BA20D			61102	2,95
6	35/35	BA20D			61103	2,95
6	45/40	P45T			61104	3,95
6	60/55	P43T	H4		61105	14,95
12	15	P26S		Halogen	61299*	5,95
12	15	P26S		mit Kragen (VPE 10)	61300	1,95
12	20	P26S		Halogen	61298*	6,95
12	25/25	BA20D			61301	3,45
12	35	PK22S	H3		61324	9,95
12	35/35	BA20D			61302	3,45
12	35/35	BA20D		Halogen	61317*	14,95
12	35/35	PX15D			61318	4,45
12	35/35	PX43T	H4		61303	8,95
12	45/40	P45T			61304	2,75
12	45/40	BA20D			61320	2,95
12	55	P14,5S	H1		61305	3,95
12	55	P14,5S	H1	Prem. + 30%	61332	7,95
12	55	P14,5S	H1	Prem. + 50%	61333	11,95
12	55	P14,5S	H1	Blue Xenon	61325	9,95
12	55	PK22S	H3		61306	3,95
12	55	PK22S	H3	Blue Xenon	61326	9,95
12	55	PX26D	H7		61307	9,95
12	55	PX26D	H7	Prem. + 30%	61334	10,95
12	55	PX26D	H7	Prem. + 50%	61335	13,95
12	55	PX26D	H7	Blue Xenon	61327	15,95
12	55	P22D	HB4		61328	8,95
12	60/55	P43T	H4		61308	5,45
12	60/55	P45T	H4		61322*	8,95
12	60/55	P43T	H4	Prem. + 30%	61321	8,95
12	60/55	P43T	H4	Prem. + 50%	61336	9,95
12	60/55	P43T	H4	All Weather	61310	11,95
12	60/55	P43T	H4	Blue Xenon	61311	15,95
12	65	P20D	HB3		61329	8,95
12	80	P22D	HB4		61330*	14,95
12	100	P20D	HB3		61331*	14,95
12	100	P14,5S	H1		61312*	6,95
12	100	PK22S	H3		61313*	6,95
12	100/90	P43T	H4		61314*	8,95
12	130/90	P43T	H4		61315*	15,95
12	160/100	P43T	H4		61316*	15,95

* = Im Geltungsbereich der StVZO nicht erlaubt

Soffitten (VPE 10)

6	5	11x39mm			61120	0,95
6	10	11x44mm			61121	1,45
6	18	15x44mm			61122	1,45
12	5	11x39mm			61420	0,95
12	10	11x39mm			61421	1,45
12	18	15x44mm			61422	1,45
12	21	15x38mm		kurz für Ochsenaugen	61423	1,45
12	21	15x44mm			61424	1,75



Maße sind nur Richtwerte zur Orientierung.

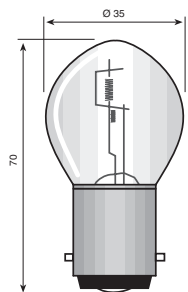

BA20D

6V	25/25W	61102
6V	35/35W	61103
12V	25/25W	61301
12V	35/35W	61302
12V	45/40W	61320



BA20D Halogen

12V	35/35W	61317
-----	--------	-------

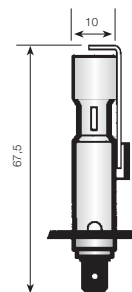

P14.55

12V	55W	61305
12V	55W	61332
12V	55W	61333
12V	55W Blue	61325
12V	100W	61312

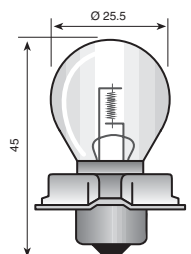

P26S

6V	15W	61101
12V	15W	61300

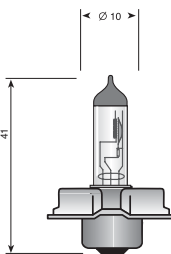

P26S Halogen

12V	15W	61299
12V	20W	61298

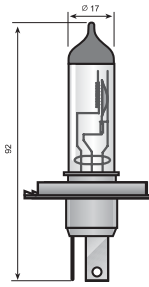

P43T

6V	60/55W	61105
12V	60/55W	61308
12V	60/55W	61321
12V	60/55W	61310
12V	60/55W	61311
12V	60/55W	61336
12V	100/90W	61314
12V	130/90W	61315

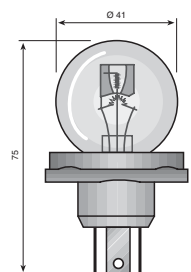
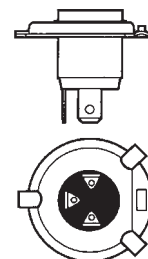

P45T

6V	45/40W	61104
12V	45/40W	61304

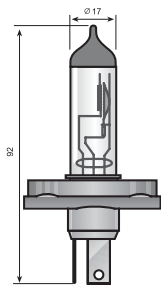

P45T Halogen

12V	60/55W	61322
-----	--------	-------

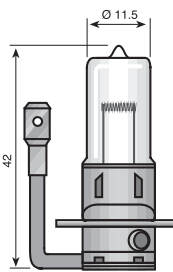
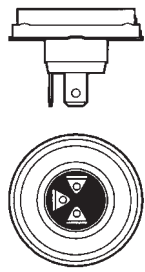

PK22S

12V	35W	61324
12V	55W	61306
12V	55W Blue	61326
12V	100W	61313

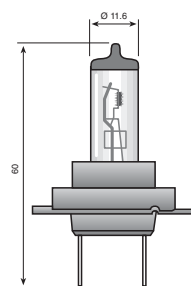
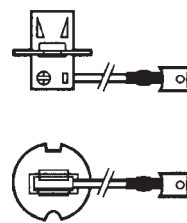

PX26D

12V	55W	61307
12V	55W Blue	61327
12V	55W	61334
12V	55W	61335

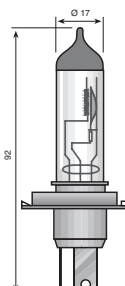
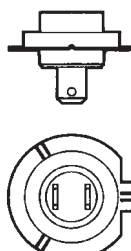

PX43T

12V	35/35W	61303
-----	--------	-------

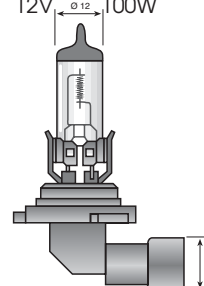
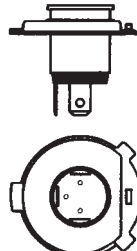

P20D/P22D

12V	55W	61328
12V	65W	61329
12V	80W	61330
12V	100W	61331

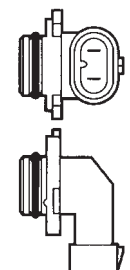

Blinker- und Bremslichtbirnen (VPE 10)

Volt	Watt	Sockel	Bemerkung	Best.-Nr.	€/Stck.
6	1,2	BA7S		61110	1,25
6	2	BA9S		61111	0,95
6	4	BA9S		61112	0,95
6	5	BA15S		61113	0,95
6	10	BA15S		61114	0,95
6	18	BA15S		61115	1,25
6	21	BA15S		61116	1,15
6	21/5	BAY15D		61117	1,25
12	2	BA7S		61400	0,95
12	2	BA9S		61401	0,95
12	4	BA9S		61402	0,85
12	5	BA15S		61403	0,85
12	6	BAX9S	Halogen passend für Micro 1000	31941	3,95
12	10	BA15S		61404	0,85
12	18	BA15S		61405	1,25
12	18/5	BAY15D		61406	1,35
12	20	BA9S	Halogen	61411	4,45
12	20	BA15S	Halogen kurz für Little Duke, Daytona alt, Duc Style,...	61410	3,95
12	21	BAY9S	Halogen für Miniblinker, Daytona neu,...	61412	4,45
12	21	BAY9S	Halogen passend für BL1000	31915	4,50
12	21	BA15S	Kugel für Little Duke, Daytona alt, Duc Style,...	61414	1,95
12	21	BA15S		61407	0,95
12	21	BA15S	gelb	61439	2,75
12	21	T15	Glassockel klar für Mini-Leuchten	61438	1,95
12	21	T15	Glassockel gelb für Mini-Leuchten	61437	2,45
12	21/5	BAY15D		61408	0,95

Glassockelbirnen (VPE 10)

12	1,2	W2x4,6D		61430	0,95
12	2	W2,1x9,5D		61431	1,25
12	3	W2,1x9,5D		61432	0,95
12	5	W2,1x9,5D		61433	0,95
12	10	W2,1x9,5D	Halogen	61434	5,95
12	21	T20		61436	2,95
12	21	T15	gelb für Mini-Leuchten	61437	2,45
12	21	T15	klar für Mini-Leuchten	61438	1,95
12	21/5	T20		61435	4,45

Sortimente

12	Ersatzkasten Motorrad mit H4	61500	7,95
12	Ersatzkasten Roller mit Kragenbirne	61502	7,45

Sortiment Farbkappen 5-fach farbig sortiert, 3 Größen, Inhalt: 128 Kappen

61504

Verkaufschrank Auf Anfrage



Maße sind nur Richtwerte zur Orientierung.

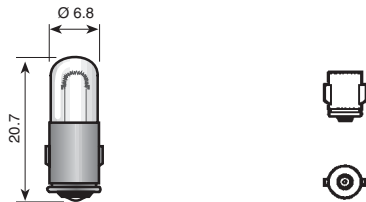

BA7S		
6V	1,2W	61110
12V	2W	61400

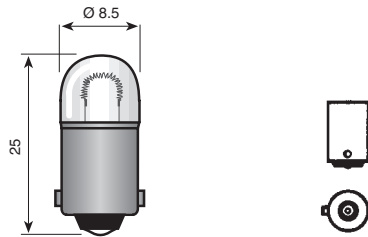

BA9S		
6V	2W	61111
6V	4W	61112
12V	2W	61401
12V	4W	61402

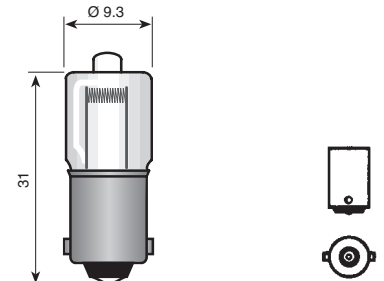

BA9S Halogen		
12V	20W	61411

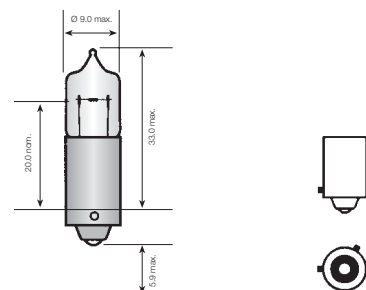

BA9S		
12V	21W	61412

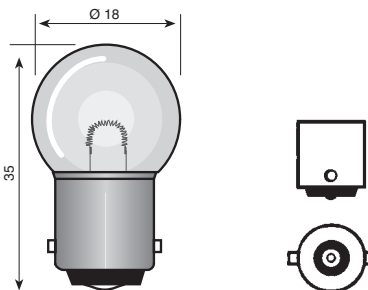

BA15S		
6V	5W	61113
6V	10W	61114
12V	5W	61403
12V	10W	61404
12V	21W	61414
12V	21W	61439

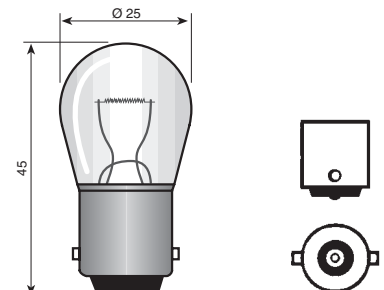

BA15S		
6V	18W	61115
6V	21W	61116
12V	18W	61405
12V	21W	61407

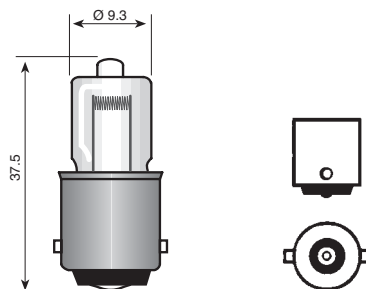

BA15S		
12V	20W	61410

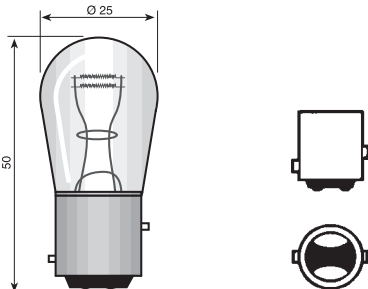

BA15D		
6V	21/5W	61117
12V	18/5W	61406
12V	21/5W	61408

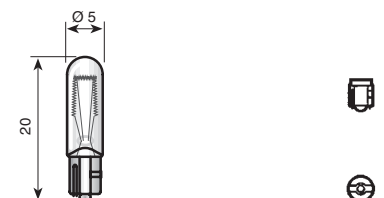

W2x4.6d		
12V	1,2W	61430

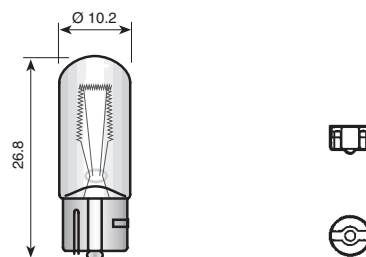

W2.1x9.5d		
12V	2W	61431
12V	3W	61432
12V	5W	61433
12V	10W Hal.	61434

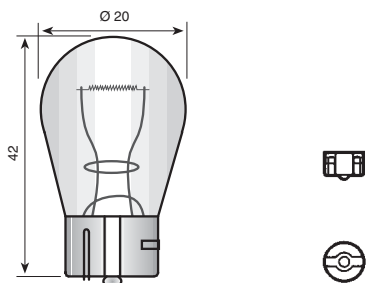

T20		
12V	21W	61436
12V	21/5W	61435

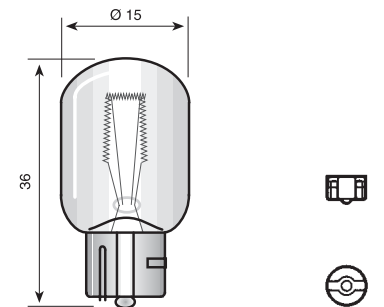

T15		
12V	21W	61437
12V	21W	61438



LED Neuheiten!

LED Technik für Jedermann, machen Sie Ihre konventionelle Leuchte zur hochmodernen LED Leuchte, indem Sie die herkömmliche Birne durch diese LED Birnen ersetzen. Extrem geringer Stromverbrauch (ca. 1/5 von herkömmlichen Glühfadenbirnen), extrem hohe Lebensdauer (100.000h im Dauerbetrieb). Gehen auch durch Vibrationen nicht kaputt. Im Bereich der STVZO nicht zugelassen. Warum keine weiss leuchtenden LED's? Zum einen eignen sich farbig leuchtende LED für klare wie eingefärbte Rücklichter oder Blinker und zum anderen sind weiß leuchtende LED um ein Vielfaches teurer.

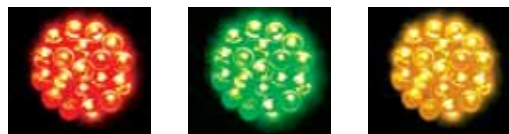

Sockel BAY15D (Ersatz für 21/5) für Rückleuchten (Brems- und Standlicht)

Best.-Nr.	Bezeichnung	Lichtfarbe	Sockel	€
61901	19 LEDs in 2 Leuchtstärken	rot	BAY15D	7,95
61903	19 LEDs in 2 Leuchtstärken	grün	BAY15D	12,50
61908	48 LEDs in 2 Leuchtstärken, Durchmesser 46mm	rot	BAY15D	15,95
61902	12 LEDs, Standlicht rotierend, Bremslicht blinkend	rot	BAY15D	9,95



Best.-Nr. 61901 und 61903



Best.-Nr. 61908



Best.-Nr. 61902 und 61909



Best.-Nr. 61904



Best.-Nr. 61905

Sockel BA15S (Ersatz für 5 bis 21W) für Rückleuchten mit separaten Leuchtmitteln für Stand- und Bremslicht.

Best.-Nr.	Bezeichnung	Lichtfarbe	Sockel	€
61904	24 LEDs für Blinker (6 davon quer z. Sockel)	gelb	BA15S	9,95
61905	19 LEDs in einer Leuchtstärke (ca. 21W)	rot	BA15S	5,95
61915	12 LEDs in einer Leuchtstärke (ca. 18W)	rot	BA15S	4,95
61912	9 LEDs in einer Leuchtstärke (ca. 10W)	rot	BA15S	4,95



Best.-Nr. 61915



Best.-Nr. 61912

LEDs für Standlicht vorne (z.B. im Scheinwerfer)

Best.-Nr.	Bezeichnung	Lichtfarbe	Sockel	€
61906	1 LED Metallsockel, z.B. für Standlicht vorne	weiss	BA9S	2,50
61907	1 LED Metallsockel z.B. für Standlicht vorne	blau	BA9S	2,50
61914	1 LED Stecksockel z.B. für Standlicht vorne	weiss	T10 Steck	2,50
61913	3LEDs Stecksockel z.B. für Standlicht vorne	blau	T10 Steck	2,50



Best.-Nr. 61906 und 61907



Best.-Nr. 61914

Best.-Nr. 61913

Best.-Nr. 61911



LED Ventilkappe (ca. 5gr. Eigengewicht)

Best.-Nr.	Bezeichnung	Lichtfarbe	Sockel	€
61911	3 LEDs leuchten durch die Fliehkraft (nicht bei abginkelten Ventilen, radialer Fliehkraftsensor)	rot/gelb/grün		15,95

BELEUCHTUNG, STURZTEILE

Hebel • Levers • Leviers

Fabrikat/ Modell	Bj.	Bremshebel Originalnummer	Cypacc- Art.-Nr.	Farbe	€	Kupplungshebel Originalnummer	Cypacc- Art.-Nr.	Farbe	€
DAELIM									
VC/VL 125	96-97	53175-KK4-010	301242	poliert	9,90	53178-440-950	311102	schwarz	9,90
VT/VL 125 Basic Star	ab 98	nicht im Progr.				53178-440-950	311112	poliert	11,90
DUCATI									
Monster 600/750/900	alle	62640071A	309101	poliert	23,90	63140091A	311132	poliert	23,90
748 Strada/ Biposto/ SP	alle	62640071A	309101	poliert	23,90	63140091A	311132	poliert	23,90
749 Strada/ Biposto/ SP	alle	63140191A	309102	poliert	39,90	63140171A	311142	poliert	39,90
750/900 SS I.E.	alle	62640071A	309101	poliert	23,90	63140091A	311132	poliert	23,90
996/998 Strada/ Biposto/ SP	alle	62640071A	309101	poliert	23,90	63140091A	311132	poliert	23,90
999 Strada/ Biposto/ SP	alle	63140191A	309102	poliert	39,90	63140171A	311142	poliert	39,90
HONDA									
C 50/ C 70/ C90	77-82	53175-147-010	301262	poliert	5,40	nicht im Progr.			
CB 50 J	CB50J	77-84	53175-149-000	301272	poliert	5,40	53178-149-000	302242	poliert 5,40
MB 50 S	AC01	80-82	53175-GE2-741	301102	schwarz	5,70	53178-166-003	302102	schwarz 5,00
MBX 50 SD	AC05	83-86	53175-GE2-741	301102	schwarz	5,70	53178-166-003	302102	schwarz 5,00
MT 50/80 S	AD01/HD02	80	53175-399-700	301112	schwarz	5,50	53178-399-700	302112	schwarz 5,00
MTX 50 S	AD04	84	53175-KB7-000	301122	schwarz	5,40	53178-KB7-000	302122	schwarz 5,00
NSR 50 S	AC08	89-95	53175-GE2-741	301102	schwarz	5,70	53178-166-003	302102	schwarz 5,00
PX 50			53175-187-000	301282	poliert	5,40	nicht im Progr.		
ST 50/ ST 70 DAX	ST50	ab 72	53178-051-000	301292	poliert	5,40	nicht im Progr.		
CR 80 R		96-99	nicht im Progr.			53178-MAC-740	302252	poliert	7,90
CR 80 R		ab 00	53175-KCE-690	301302	poliert	9,80	53178-KA3-741	302262	poliert 7,90
MB/MBX/MCX 80	HC01/04/05	80-86	53175-GE2-741	301102	schwarz	5,70	53178-166-003	302102	schwarz 5,00
MT 80S	HD02	80	53175-399-700	301112	schwarz	5,50	53178-399-700	302112	schwarz 5,00
MTX 80	HD06	82	53175-KB7-000	301122	schwarz	5,40	53178-KB7-000	302122	schwarz 5,00
MTX 80 R	HD08	83-84	53175-KE1-000	301132	schwarz	5,00	53178-KE1-000	302132	schwarz 5,00
MTX 80 R2	HD09	85-87	53175-KJ1-730	301322	schwarz	6,20	53178-KE1-000	302132	schwarz 5,00
XR 80 R		96-03	53175-KTO-840	301342	poliert	8,90	53178-GN1-A00	302272	poliert 8,90
CR 85 R		ab 03	53175-KCE-690	301302	poliert	9,80	53178-KA3-741	302262	poliert 7,90
CB 100	CB100	70-72	53175-063-010	301362	poliert	5,40	53178-063-010	302282	poliert 5,40
CB 100 N	CB100N	ab 78	53175-399-700	301112	schwarz	5,50	53178-399-700	302112	schwarz 5,00
XR 100 R		96-03	53175-KTO-840	301342	poliert	8,90	53178-GN1-A00	302272	poliert 8,90
CA 125 Rebell	JC24	ab 95	53175-KR3-601	301382	poliert	12,90	53178-KV0-000	302142	poliert 5,90
CB 125 J/T; TL 125 S	CB125J	75-81	53175-369-700	301402	poliert	5,40	53178-369-700	302232	poliert 15,90
CB 125 TD/ CM 125 C	JC05	ab 82	53175-399-700	301112	schwarz	5,50	53178-399-700	302112	schwarz 5,00
CR 125 R		ab 96	53175-KCE-690	301302	poliert	9,80	53178-MAC-740	302252	poliert 7,90
NSR 125		98-	53175-KBS-900	301232		10,28	53178-KV0-000	302442	in Vorb.
XL 125/185 S	XL125/L185S	80-83	53175-399-700	301112	schwarz	5,50	53178-399-700	302112	schwarz 5,00
CRF 150 F		ab 03	53175-KCE-690	301302	poliert	9,80	53178-KPS-900	302292	poliert 10,90
CM 185 T/ CB 185 T	CM185T	78-79	53175-369-700	301402	poliert	5,40	53178-369-700	302232	poliert 15,90
CB 200 T	CB200T	74-76	53175-369-003	301422	poliert	5,40	53178-369-700	302232	poliert 15,90
CM 200 T	MC01	78-80	53175-369-700	301402	poliert	5,40	53178-369-700	302232	poliert 15,90
CM 200 T	MC01	80-81	53175-399-700	301112	schwarz	5,50	53178-399-700	302112	schwarz 5,00
MTX 200 RW	MD07	83-84	53175-KE1-000	301132	schwarz	5,00	53178-KE1-000	302132	schwarz 5,00
XL 200 R	MD06	83-85	53175-KB7-000	301122	schwarz	5,40	53178-KB7-000	302122	schwarz 5,00
XR 200 R		96-04	53175-KTO-840	301342	poliert	8,90	53178-GN1-A00	302272	poliert 8,90
CRF 230		ab 04	53175-KCE-690	301302	poliert	9,80	53178-KPS-900	302292	poliert 10,90
CB 250 G/ K3-5/ C.J 250 T	CB250G	73-75	53175-369-003	301422	poliert	5,40	53178-369-700	302232	poliert 15,90
CB 250 N/ND	CB250T	79-80	53175-422-000	301152	schwarz	5,90	53190-443-610	302112	schwarz 5,00
CB 250 N/ND	CB250N	81-83	53175-MA5-671	301142	schwarz	5,00	53190-443-610	302112	schwarz 5,00
CB 250 RS	MC02	80-81	53175-422-000	301152	schwarz	5,90	53190-443-610	302112	schwarz 5,00
CB 250 RS	MC02	82-84	53175-MA5-670	301142	schwarz	5,00	53190-443-610	302112	schwarz 5,00
CJ 250 T		77	53175-MA5-671	301142	schwarz	5,00	nicht im Progr.		
CL 250 S	MD04	81-82	53175-399-700	301112	schwarz	5,50	53178-399-700	302112	schwarz 5,00
CM 250 C	MC06	82-83	53175-399-700	301112	schwarz	5,50	53178-399-700	302112	schwarz 5,00
CMX 250 C Rebell	MC13	ab 87	53175-KK4-010	301242	poliert	9,90	53178-KV0-000	302142	poliert 5,90
CR 250 R		ab 96	53175-KCE-690	301302	poliert	9,80	53178-MAC-740	302252	poliert 7,90
NX 250	MD21	ab 88	53175-KM9-006	301162	poliert	7,00	53178-KV0-000	302142	poliert 5,90
NX 250	MD25	91-96	53175-KM9-007	301162	poliert	7,00	53178-KV0-000	302142	poliert 5,90
XL 250 S	L250S	78-81	53175-399-700	301112	schwarz	5,50	53178-399-700	302112	schwarz 5,00
XL 250 R	MD03	82-83	53175-KB7-000	301122	schwarz	5,40	53178-KB7-000	302122	schwarz 5,00
XL 250 R	MD11	84-87	53175-KE1-000	301132	schwarz	5,00	53178-KE1-000	302132	schwarz 5,00
XR 250 R	ME06	84-95	53175-MK2-770	301442	schwarz	9,90	53178-KF0-000	302302	schwarz 8,50
XR 250 R		ab 96	53175-KCE-690	301302	poliert	9,80	53178-MAC-740	302252	poliert 7,90
CB 350/400 Four	CB350/400F	73-77	53175-369-003	301422	poliert	5,40	53178-369-700	302232	poliert 15,90
XL 350 R	ND03	85-87	53175-MG3-640	301462	schwarz	6,20	53178-KE1-000	302132	schwarz 5,00
XR 350 R		ab 83	53175-KF0-000	301482	schwarz	6,20	53178-KF0-000	302302	schwarz 8,50
CB 360 G/ C.J 360 T	CB/CJ360	75-76	53175-369-003	301422	poliert	5,40	53178-369-700	302232	poliert 15,90
CB 400 N	CB400T	79-80	53175-422-000	301152	schwarz	5,90	53190-443-610	302112	schwarz 5,00
CB 400 N	CB400N	81-83	53175-MA5-671	301142	schwarz	5,00	53190-443-610	302112	schwarz 5,00
CB 400/ CB1	NC27	ab 89	53175-ML5-006	301502	poliert	13,90	53178-KV0-000	302142	poliert 5,90
CM 400 T	NC01	79-80	53175-422-000	301152	schwarz	5,90	nicht im Progr.		



BELEUCHTUNG, STURZTEILE

Hebel • Levers • Leviers

Fabrikat/ Modell	Bj.	Bremshebel Originalnummer	Cypacc- Art.-Nr.	Farbe	€	Kupplungshebel Originalnummer	Cypacc- Art.-Nr.	Farbe	€
CM 400 T	NC01	81-83	53175-MA5-671	301142	schwarz	5,00	nicht im Progr.		
NSR 400 R	NC19	ab 85	53175-KM9-006	301162	poliert	7,00	53178-KM9-000	302152	poliert 6,50
VFR 400 R	NC30	ab 90	53170-KV0-006	301172	poliert	14,20	53178-KV3-000	302152	poliert 6,50
XR 400 R		ab 96	53175-KCE-690	301302	poliert	9,80	53178-MAC-740	302252	poliert 7,90
CB 450 K1-5	CB450K	69-75	53175-369-003	301422	poliert	5,40	53178-369-700	302232	poliert 15,90
CB 450 N	PC14	85	53175-MA6-016	301142	schwarz	5,00	53190-443-610	302112	schwarz 5,00
CB 450 S	PC17	86-89	53175-MJ6-006	301182	schwarz	7,00	53178-MF8-000	302162	schwarz 5,00
CRF 450 R		ab 02	53170-MEB-003	301522	poliert	10,90	53178-MEN-670	302312	poliert 10,90
CB 500 /S	PC26/32	ab 93	53175-MR1-671	301162	poliert	7,00	53178-KV0-000	302142	poliert 5,90
CB 500 K1-2/T	CB500T	71-75	53175-369-003	301422	poliert	5,40	53178-369-700	302232	poliert 15,90
CB 500 F/ Four	CB500F	70-77	53175-369-003	301422	poliert	5,40	53178-369-700	302232	poliert 15,90
CR 500 R		ab 96	53175-KCE-690	301302	poliert	9,80	53178-MAC-740	302252	poliert 7,90
CX 500/ CX 500C	CX500/PC01	79-80	53175-422-000	301152	schwarz	5,90	53190-443-610	302112	schwarz 5,00
CX 500/ CX 500C	CX500/PC01	81-82	53175-MA5-671	301142	schwarz	5,00	53190-443-610	302112	schwarz 5,00
CX 500 E	PC06	82-84	53175-MA5-671	301142	schwarz	5,00	53178-MA6-000	302322	poliert 5,40
CX 500 T Turbo	PC03	81-82	53175-MA5-671	301142	schwarz	5,00	53178-425-003	302172	schwarz 5,00
FT 500	PC07	82-85	53175-MB0-006	301182	schwarz	7,00	53190-MC8-000	302332	poliert 8,50
GB 500 Clubmann	PC16	ab 89	53175-KM9-006	301162	poliert	7,00	53178-KM9-000	302152	poliert 6,50
GL 500 D	PC02	82	53175-MA5-671	301142	schwarz	5,00	53178-425-003	302172	schwarz 5,00
VF 500 F/FI	PC12	84-85	53175-KE8-006	301182	schwarz	7,00	53178-KE8-006	302342	schwarz 8,50
VT 500 C/E	PC08/11	83-84	53175-KE8-006	301182	schwarz	7,00	53178-MF5-000	302212	schwarz 6,10
XBR 500 S	PC15	ab 85	53175-KE8-006	301182	schwarz	7,00	53178-MF8-000	302162	schwarz 5,00
XL 500 R	PD02	82-86	53175-KB7-000	301122	schwarz	5,40	53178-KB7-000	302122	schwarz 5,00
XL 500 S	PD01	79-81	53175-435-000	301112	schwarz	5,50	53178-443-610	302112	schwarz 5,00
CB 550 F1/F2/K3	CB550F/K3	75-78	53175-369-003	301422	poliert	5,40	53178-369-700	302232	poliert 15,90
CBX 550 F/FI	PC04	82-83	53175-MA6-016	301182	schwarz	7,00	53178-MA6-000	302322	schwarz 5,40
CB 600 F Hornet	PC34	ab 98	53170-MY9-861	301222	poliert	15,30	53178-KV0-000	302142	poliert 5,90
CBR 600 F	PC19	87-88	53175-KM9-006	301162	poliert	7,00	53178-KV3-000	302152	poliert 6,50
CBR 600 F	PC23/25	89-93	53170-KV0-006	301172	poliert	14,20	53178-KV3-000	302152	poliert 6,50
CBR 600 F	PC25/31	94-98	53170-MW0-006	301222	poliert	15,30	53178-KV0-000	302142	poliert 5,90
CBR 600 F	PC35	99-01	53170-MW0-006	301222	poliert	15,30	53178-KV0-000	302142	poliert 5,90
CBR 600 F/RR	PC35	ab 02	53170-MEE-006	301542	poliert	35,90	53178-KV0-000	302142	poliert 5,90
CBR 600 F/RR	PC37	ab 02	53170-MEE-006	301542		35,90	53182-MEE-000	302452	in Vorb.
VT 600 C Shadow	PC21	ab 88	53175-MR1-671	301162	poliert	7,00	53178-KV0-000	302142	poliert 5,90
XL 600 LM/RM	PD04	85-87	53175-MG7-006	301192	schwarz	5,30	53178-MG7-003	302192	schwarz 6,50
XL 600 R	PD03	83-87	53175-MG3-640	301462	schwarz	6,20	53178-KE1-000	302132	schwarz 5,00
XL 600 V Transalp	PD06	87-93	53175-MM9-006	301192	schwarz	5,30	53178-MG7-003	302192	schwarz 6,50
XL 600 V Transalp	PD06	94-96	53185-MN9-305	301562	schwarz	15,90	53178-MG7-003	302192	schwarz 6,50
XL 600 V Transalp	PD10	97-99	53175-MAB-621	301582	schwarz	15,90	53178-MAN-600	302192	schwarz 6,50
XR 600 R	PE04	85-93	53175-MK2-770	301442	schwarz	9,90	53178-KF0-000	302302	schwarz 8,50
CB 650 /C	RC03/05	79-80	53175-422-000	301152	schwarz	5,90	53178-425-003	302172	schwarz 5,00
CB 650 /C	RC03/05	81	53175-MA5-671	301142	schwarz	5,00	53178-425-003	302172	schwarz 5,00
CB 650 SC	RC08	ab 82	53175-MA5-671	301142	schwarz	5,00	53178-MC3-700	302162	schwarz 5,00
CBX 650 E	RC13	ab 83	53175-MB0-006	301182	schwarz	7,00	53178-MB0-006	302182	schwarz 6,50
CX 650 C	RC11	83	53175-MA6-016	301182	schwarz	7,00	53178-MC3-700	302162	schwarz 5,00
CX 650 E	RC12	83	53175-MA5-671	301142	schwarz	5,00	53178-MA6-000	302322	schwarz 5,40
CX 650 T Turbo	RC16	83	53175-MA5-671	301142	schwarz	5,00	53178-425-003	302172	schwarz 5,00
FX 650 Vigor	RD09	ab 99	53175-MAB-621	301582	schwarz	15,90	53178-MAN-600	302192	schwarz 6,50
GL 650 D	RC10	83	53175-MA5-671	301142	schwarz	5,00	53178-425-003	302172	schwarz 5,00
NT 650	RC31	88-90	53175-MR1-670	301162	poliert	7,00	53178-KV0-000	302142	poliert 5,90
NTV 650 Revere	RC33	88-97	53175-MR1-671	301162	poliert	7,00	53178-KV0-000	302142	poliert 5,90
NX 650 Dominator	RD02	88	53175-MM9-006	301192	schwarz	5,30	53178-MG7-003	302192	schwarz 6,50
NX 650 Dominator	RD02	89-94	53175-MN9-670	301202	schwarz	9,90	53178-MG7-003	302192	schwarz 6,50
NX 650 Dominator	RD08	ab 95	53175-MAB-621	301582	schwarz	15,90	53178-MAN-600	302192	schwarz 6,50
SLR 650	RD09	97-98	53175-MAB-621	301582	schwarz	15,90	53178-MAN-600	302192	schwarz 6,50
XR 650 R		ab 02	53175-KCE-690	301302	poliert	9,80	53178-MAC-740	302252	poliert 7,90
XRV 650 Africa Twin	RD03	88-89	53185-MN9-305	301562	schwarz	15,90	53178-MG7-003	302192	schwarz 6,50
CB 750 C (DOHC)	RC06	80-82	53175-MA5-671	301142	schwarz	5,00	53178-425-003	302172	schwarz 5,00
CB 750 F1 (OHC) Sport	CB750F	75-76	53175-300-020	301422	poliert	5,40	53178-369-700	302232	poliert 15,90
CB 750 F2 (OHC) Super Sport	CB750G	77-78	53175-431-670	301602	poliert	6,20	53190-410-000	302352	poliert 6,20
CB 750 K0-K7 (OHC)	CB750K	70-78	53175-369-003	301422	poliert	5,40	53178-369-700	302232	poliert 15,90
CB 750 F/KZ (DOHC)	RC01	79-80	53175-438-010	301152	schwarz	5,90	53178-425-003	302172	schwarz 5,00
CB 750 F/FI (DOHC)	RC04	81-83	53175-MA5-671	301142	schwarz	5,00	53178-425-003	302172	schwarz 5,00
CB 750 Seventy	RC42	ab 92	53175-ML5-006	301502	poliert	13,90	53178-KV0-000	302142	poliert 5,90
CBX 750	RC17	84-86	53175-KE8-006	301182	schwarz	7,00	53178-KE8-006	302182	schwarz 6,50
RVF 750	RC45	ab 94	53170-MW0-006	301222	poliert	15,30	53180-ML7-691	302222	poliert 15,30
VF 750 C	RC43	ab 93	53175-MR1-671	301162	poliert	7,00	53178-KV0-000	302142	poliert 5,90
VF 750 C/F/S	RC09/07/15	82-85	53175-KE8-006	301182	schwarz	7,00	53178-KE8-006	302182	schwarz 6,50
VFR 750 F	RC24	86	53175-MJ4-701	301622	poliert	11,90	53178-MJ4-701	302372	poliert 11,90
VFR 750 F	RC24/36	87-93	53170-KV0-006	301172	poliert	14,20	53180-ML7-691	302222	poliert 15,30
VFR 750 F	RC36	94-97	53170-MW0-006	301222	poliert	15,30	53180-ML7-691	302222	poliert 15,30
VFR 750 R	RC30	88-89	53170-KV0-006	301172	poliert	14,20	53180-ML7-691	302222	poliert 15,30
VT 750 C	RC29	87-89	53175-KE8-006	301182	schwarz	7,00	53178-KE8-006	302182	schwarz 6,50

BELEUCHTUNG, STURZTEILE

Hebel • Levers • Leviers

Fabrikat/ Modell	Bj.	Bremshebel Originalnummer	Cypacc- Art.-Nr.	Farbe	€	Kupplungshebel Originalnummer	Cypacc- Art.-Nr.	Farbe	€	
VT 750 Shadow ACE	RC44	97-00	53175-KM9-006	301162	poliert	7,00	53178-MAH-000	302142	poliert	5,90
VT 750 Black Widow	RC48	ab 00	53175-KM9-006	301162	poliert	7,00	53178-MAH-000	302142	poliert	5,90
XLV 750 R	RD01	83-85	53175-MG7-006	301192	schwarz	5,30	53178-MG7-003	302192	schwarz	6,50
XRV 750 Africa Twin	RD04	90-95	53185-MN9-305	301562	schwarz	15,90	53178-MG7-003	302192	schwarz	6,50
XRV 750 Africa Twin	RD07	ab 96	53185-MN9-305	302432	schwarz	15,90	53178-MAN-600	302432	schwarz	6,50
VFR 800	RC46	ab 98	53170-MAT-006	301212	poliert	15,30	53180-MZ1-791	302222	poliert	15,30
VT 800 C Shadow		ab 90	53175-MR1-671	301162	poliert	7,00	53178-MJ0-921	302202	poliert	6,50
CB 900 F	SC01	79	53175-438-010	301152	schwarz	5,90	53178-422-010	302322	schwarz	5,40
CB 900 F	SC01	80-81	53175-438-010	301152	schwarz	5,90	53178-MC3-700	302162	schwarz	5,00
CB 900 F/Fil	SC09	82-83	53175-MA5-671	301142	schwarz	5,00	53178-MC3-700	302162	schwarz	5,00
CB 900 Hornet	SC48	ab 02	53170-MBR-J11	301642	poliert	39,90	53178-MAH-000	302142	poliert	5,90
CBR 900 RR	SC28/33	92-97	53170-KV0-006	301172	poliert	14,20	53178-KV3-000	302152	poliert	6,50
CBR 900 RR	SC33	98-99	53170-MY9-861	301222	poliert	15,30	53178-KV3-000	302152	poliert	6,50
CBR 900 RR	SC44/50	00-03	53170-MCF-006	301662	poliert	23,90	53178-KV3-000	302152	poliert	6,50
CB 1000 Big One	SC30	93-96	53170-MW0-006	301222	poliert	15,30	53180-MZ1-791	302222	poliert	15,30
CBR 1000 F	SC21/24	87-92	53170-KV0-006	301172	poliert	14,20	53178-MM5-006	302202	poliert	6,50
CBR 1000 F	SC24	ab 93	53170-MW0-006	301222	poliert	15,30	53180-MZ1-791	302222	poliert	15,30
CBR 1000 RR	SC57	ab 04	53170-MEL-006	301682	poliertin	Vorb.	53180-MEJ-006	302362	poliert	35,90
CBX 1000	SC01/CB1	79-80	53175-438-010	301152	schwarz	5,90	53178-422-010	302322	schwarz	5,40
CBX 1000	SC06	81-82	53175-MA5-671	301142	schwarz	5,00	53178-MC3-700	302162	schwarz	5,00
GL 1000 Gold Wing (K0/K1)	GL1	75-76	53175-369-003	301422	poliert	5,40	53178-369-700	302232	poliert	15,90
GL 1000 Gold Wing (K3)	GL2	77-79	53175-431-670	301602	poliert	6,20	53190-401-651	302352	poliert	6,20
VF 1000 F/Fil	SC15	84-86	53175-KE8-006	301182	schwarz	7,00	53178-KE8-006	302182	schwarz	6,50
VF 1000 R	SC16	84	53175-MJ4-701	301622	poliert	11,90	53178-KE8-006	302182	schwarz	6,50
VF 1000 R	SC16	85-86	53175-MJ4-701	301622	poliert	11,90	53178-MJ4-701	302372	poliert	11,90
VT 1100 Shadow ACE	SC32	95-00	53175-ML5-006	301502	poliert	13,90	53178-MAH-000	302142	poliert	5,90
VT 1100 Shadow Aero	SC39	98-00	53175-ML5-006	301502	poliert	13,90	53178-MAH-000	302142	poliert	5,90
VTR 1000 F Firestorm	SC36	ab 97	53170-MW0-006	301222	poliert	15,30	53180-MZ1-791	302222	poliert	15,30
VTR 1000 SP1	SC45	ab 00	53170-MCF-006	301662	poliert	23,90	53180-MZ1-791	302222	poliert	15,30
XL 1000 Varadero	SD01	ab 99	53170-MAT-006	301212	poliert	15,30	53180-MZ1-791	302222	poliert	15,30
CB 1100 F/R	SC05/08/11	81-83	53175-MA5-671	301142	schwarz	5,00	53178-MC3-700	302162	schwarz	5,00
CB 1100 SF (X-11)	SC42	ab 00	53170-MAT-006	301212	poliert	15,30	53178-MAH-000	302142	poliert	5,90
CBR 1100 XX	SC35	ab 97	53170-MAT-006	301212	poliert	15,30	53180-MZ1-791	302222	poliert	15,30
GL 1100 Gold Wing	SC02	80-81	53175-422-000	301152	schwarz	5,90	53178-431-780	302382	schwarz	8,50
GL 1100 Gold Wing	SC02	82-83	53175-MA5-671	301142	schwarz	5,00	53178-MB9-000	302392	schwarz	8,50
ST 1100 Pan European	SC26	90-96	53170-MT3-305	301702	schwarz	17,90	53178-KE8-006	302182	schwarz	6,50
VF 1100 C	SC12	83-86	53175-KE8-006	301182	schwarz	7,00	53178-KE8-006	302182	schwarz	6,50
VT 1100 C Shadow	SC18	85-88	53175-KM9-006	301162	poliert	7,00	53178-MJ0-921	302202	poliert	6,50
VT 1100 C Shadow	SC23	88-93	53175-MR1-671	301162	poliert	7,00	53178-MJ0-921	302202	poliert	6,50
VT 1100 C2	SC32	94-96	53175-MR1-671	301162	poliert	7,00	53178-MJ0-921	302202	poliert	6,50
VT 1100 C3	SC39	ab 98	53175-MR1-671	301162	poliert	7,00	53178-MJ0-921	302202	poliert	6,50
GL 1200 Gold Wing	SC14	84-87	53175-MA6-016	301182	schwarz	7,00	53178-MG9-006	302402	schwarz	8,50
VTX 1300	SC52	ab 03	53175-MR1-671	301162	poliert	7,00	53178-MJ0-921	302202	poliert	6,50
GL 1500 Gold Wing	SC22	ab 88	53175-MN5-006	301722	schwarz	9,20	53178-MN5-006	302412	schwarz	9,20
GL 1500 F 6 C Valkyre	SC34B	ab 96	53175-MR1-671	301162	poliert	7,00	53178-MJ0-921	302202	poliert	6,50
VTX 1800	SC46	ab 02	53175-MR1-671	301162	poliert	7,00	53178-MJ0-921	302202	poliert	6,50

*301172 auch lieferbar als Hebel ohne Einsteller

*302222 auch lieferbar als Hebel ohne Einsteller

*301702 auch lieferbar als Hebel ohne Einsteller

KAWASAKI

KX 65/ KX 85		ab 00	13236-1346	303222	poliert	9,20	46092-1165	304222	poliert	8,50
KX 80/ KX 100		83-97					46092-1110	304232	poliert	6,20
KX 80/ KX 100		ab 98					46092-1165	304222	poliert	8,50
KX 80		94-95	46092-1177/86	303232	poliert	9,80				
KX 80		96-00	46092-1191	303242	poliert	8,50				
KX 125/ KX 250/ KX500		82-89					46092-1110	304232	poliert	6,20
KX 125/ KX 250/ KX500		ab 90					46092-1165	304222	poliert	8,50
KX 100/ KX 500		95-96	46092-1177/86	303232	poliert	9,80				
KX 100/ KX 500		97-00	46092-1191	303242	poliert	8,50				
KX 125/ KX 250		93-96	46092-1177/86	303232	poliert	9,80	46092-1165	304222	poliert	8,50
KX 125/ KX 250		97-99	46092-1191	30242	poliert		46092-1165	304222	poliert	8,50
KX 125/ KX 250		ab 00	13236-1346	303222	poliert	9,20	46092-1165	304222	poliert	8,50
KDX 200/ KDX 220		ab 95	46092-1177/86	303232	poliert	9,80	46092-1110	304232	poliert	6,20
BJ 250	Estrella	94-97	13236-1221	303182	poliert	16,50	46092-1161	304152	schwarz	8,20
EL 250 Eliminator	EL250B/E	ab 88	46092-1117	303102	schwarz	6,90	46092-1103	304102	schwarz	6,20
S1-250 MACH I	S1	73-76	46058-012	303252	poliert	6,20	46092-016	304242	poliert	5,40
KH 250 (3 Zyl.-2 Takt)	KH250B	76-77	43029-003	301422	poliert	5,40	46092-022	304132	poliert	6,50
KLR 250 (D2-9)	KL250D	85-93	46092-1114	303112	schwarz	5,40	46092-1111	304112	schwarz	6,50
KLR 250 (D10-14)	KL250D	93-97	46092-1135	303112	schwarz	5,40	46092-1111	304112	schwarz	6,50
KLX 250		94-96	46092-1177/86	303232	poliert	9,80	46092-1110	304232	poliert	6,20
Z 250 A/ Z 250 J	KZ250A	79-82	46092-1004	303142	poliert	5,70	46092-023	304132	poliert	6,50
Z 250 GP Belt Drive /GPZ 250C	EX250C	83	46092-1026	303132	schwarz	5,70	46092-1024	304112	schwarz	6,50

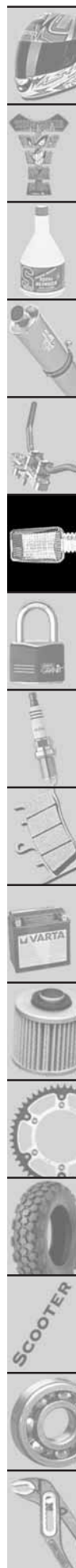

BELEUCHTUNG, STURZTEILE

Hebel • Levers • Leviers

Fabrikat/ Modell	Bj.	Bremshebel Originalnummer	Cypacc- Art.-Nr.	Farbe	€	Kupplungshebel Originalnummer	Cypacc- Art.-Nr.	Farbe	€	
KLX 300	ab 97	46092-1177/86	303232	poliert	9,80	46092-1110	304232	poliert	6,20	
GPZ 305/ Z 305 GP/ BD/UT	83-90	46092-1026	303132	schwarz	5,70	46092-1024	304112	schwarz	6,50	
S2-350 MACH II	S2	46058-012	303252	poliert	6,20	46092-016	304242	poliert	5,40	
GPZ 400 (4 Zyl.)	ZX400A	46092-1026	303132	schwarz	5,70	46092-1103	304102	schwarz	6,20	
KH 400 (3 Zyl.-2 Takt)	S3	43029-003	301422	poliert	5,40	46092-016	304242	poliert	5,40	
KLX 400	ab 03	46092-1177/86	303232	poliert	9,80	46092-1110	304232	poliert	6,20	
Z 400 B/D/G (2Zyl.)	KZ400/K4	43029-002	301422	poliert	5,40	46092-016	304242	poliert	5,40	
Z 400 F (4 Zyl.)	ZR400B	46092-1043	303262	schwarz	8,50	46092-1041	304252	schwarz	8,50	
Z 400 GP (4 Zyl.)	KZ400M	46092-1026	303132	schwarz	5,70	46092-1024	304112	schwarz	6,50	
Z 400 J (4 Zyl.)	KZ400J	80-82	46092-1004	303142	poliert	5,70	46092-022	304132	poliert	6,50
ZXR 400	ZX400L	ab 91	13236-1226	305132	poliert	15,30	46076-1168/80	304262	poliert	23,90
EN 450	85	46092-1008	303142	poliert	5,70	46092-023	304132	poliert	6,50	
Z 440 (2 Zyl.)	KZ440C/H	80-83	46092-1008	303142	poliert	5,70	46092-023	304132	poliert	6,50
Z 440 LTD (A1-3/D4-5)	KZ440A/D	80-83	46092-1009	303272	poliert	8,50	46092-023	304132	poliert	6,50
Z 440 LTD (D6)	KZ440D	84	nicht im Progr.	schwarz		46092-1041	304252	schwarz	8,50	
LTD 450	EN450A	85-89	46092-1027	303152	schwarz	9,40	46092-1103	304102	schwarz	6,20
EN 500	EN500A/B	90-95	46092-1172	303162	poliert	6,60	46092-1164	304142	poliert	8,20
ER 5	ER500A1	97	46092-1171	303282	poliert	8,50	46092-1181	304352	poliert in Vorb.	
ER 5 Twister	ER500A	ab 98	13236-1226	305132	poliert	15,30	46076-1168/80	304262	poliert	23,90
GPZ 500 S (A1/B1-4)	EX500A/B	87-91	46092-1117	303102	schwarz	6,90	46092-1103	304102	schwarz	6,20
GPZ 500 S (B5-6/E1-2)	EX500B/E	ab 92	13236-1185	303172	schwarz	16,50	46092-1165	304272	schwarz	11,90
H1-500 MACH III (Trommelbr.)	H1A	69-72	46058-012	303252	poliert	6,20	46092-016	304242	poliert	5,40
H1-500 MACH III (Scheibenbr.)	H1B/D/E	73-75	43029-002	301422	poliert	5,40	46092-016	304242	poliert	5,40
KH 500 (3 Zyl.-2 Takt)	H1F	76	43029-003	301422	poliert	5,40	46092-022	304132	poliert	6,50
Z 500	KZ500B	79-80	46092-1004	303142	poliert	5,70	46092-022	304132	poliert	6,50
GPZ 550 UniTrak	ZX550A	84-89	43092-1026	303132	schwarz	5,70	46092-1103	304102	poliert	6,20
GT 550 (G1)	KZ550G	83	46092-1026	303132	schwarz	5,70	46092-1024	304112	schwarz	6,50
GT 550 (G2-6)	KZ550G	84-89	46092-1026	303132	schwarz	5,70	46092-1103	304102	schwarz	6,20
Z 550 (A1-2)	KZ550A	80-81	46092-1004	303142	poliert	5,70	46092-022	304132	poliert	6,50
Z 550 F Unitrak (A3-4)	KZ550A	82-83	46092-1043	303262	poliert	8,50	46092-022	304132	poliert	6,50
Z 550 F Unitrak (A1-2)	ZR550A	83-86	46092-1043	303262	poliert	8,50	46092-1041	304252	schwarz	8,50
Z 550 GP	KZ550H	82-83	46092-1026	303132	schwarz	5,70	46092-1024	304112	schwarz	6,50
Z 550 LTD	KZ550C	80-83	46092-1012	303272	poliert	8,50	46092-022	304132	poliert	6,50
ZR 550 Zephyr	ZR550B	ab 91	13236-1221	303182	poliert	16,50	46076-1168/80	304262	poliert	23,90
GPX/GPZ 600 R	ZX600A/C	85-95	46092-1117	303102	schwarz	6,90	46092-1050	304172	schwarz	5,70
KLR 600	KL600A/B	84-89	46092-1114	303112	schwarz	5,40	46092-1111	304112	schwarz	6,50
ZL 600 Eliminator	ZL600A	86-88	nicht im Progr.	poliert		46092-1126	304292	poliert	8,90	
ZL 600 Eliminator	ZL600B	96-97	46092-1172	303162	poliert	6,60	46092-1164	304142	poliert	8,20
ZX 6 R Ninja	ZX600F	95-97	13236-1185	303172	schwarz	16,50	46092-1165	304272	schwarz	11,90
ZX 6 R Ninja	ZX600G	98-99	13236-1310	303192	poliert	15,30	46076-1168/80	304262	poliert	23,90
ZX 6 R Ninja	ZX600H	ab 00	13236-1310	303192	poliert	15,30	46092-1211	304302	poliert	8,50
ZXR 600	ZX600D/E	ab 90	13236-1185	303172	schwarz	16,50	46092-1165	304272	schwarz	11,90
KLR 650 / Tengai	KL650A/C	87-00	46092-1135	303112	schwarz	5,40	46092-1111	304112	schwarz	6,50
KLX 650	LX650C	93-96	46092-1175	303292	poliert	6,20	46092-1159	304322	poliert	6,90
KLX 650 R	LX650A	93-98	46092-1177/86	303232	poliert	9,80	46092-1110	304232	poliert	6,20
W 650			46092-1172	303162	poliert	6,60	nicht im Progr.			
Z 650 B (B1/2)	KZ650B	77-78	43029-003	301422	poliert	5,40	46092-022	304132	poliert	6,50
Z 650 /SR	KZ650C/D	78-80	46092-1002		poliert		46092-022	304132	poliert	6,50
Z 650 (F2)	KZ650F	81	46092-1004	303142	poliert	5,70	46092-022	304132	poliert	6,50
Z 650 (F3-4)	KZ650F	82-83	46092-1004	303142	poliert	5,70	46092-1005	304332	poliert	8,50
750 MACH IV (3Zyl.-2 Takt)	H2	72-75	43029-002	301422	poliert	5,40	46092-016	304242	poliert	5,40
GPX 750 R	ZX750F	87-90	46092-1117	303102	schwarz	6,90	46092-1130	304182	schwarz	5,70
GPz 750	KZ750R1	82	46092-1026	303132	schwarz	5,70	46092-1024	304112	schwarz	6,50
GPZ 750 UniTrak	ZX750A	83-85	46092-1027	303152	schwarz	9,40	46092-1050	304172	schwarz	5,70
GPZ 750 R	ZX750G	85-86	46092-1117	303102	schwarz	6,90	46092-1130	304182	schwarz	5,70
GPZ 750 Turbo	ZX750E	84-85	46092-1027	303152	schwarz	9,40	46092-1050	304172	schwarz	5,70
GT 750 (4 Zyl.)	KZ750P	82-83	46092-1026	303132	schwarz	5,70	46092-1024	304112	schwarz	6,50
GT 750 (4 Zyl.)	KZ750P	84-85	46092-1026	303132	schwarz	5,70	46092-1103	304102	schwarz	6,20
VN 750 (A2-4)	VN750A	86-89	46092-1150		poliert		46092-1151	304292	poliert	8,90
VN 750 (A10-14)	VN750A	94-04	46092-1171	303282	poliert	8,50	nicht im Progr.			
Z 750	ab 04	13236-1310	303192	poliert	15,30	46092-1211	304302	poliert	8,50	
Z 750 B (2 Zyl.)	KZ750B	76-78	43029-003	301422	poliert	5,40	46092-022	304132	poliert	6,50
Z 750 E (L1) (4 Zyl.)	KZ750E	80-81	46092-1004	303142	poliert	5,70	46092-022	304132	poliert	6,50
Z 750 E (L2) (4 Zyl.)	KZ750E	82	46092-1004	303142	poliert	5,70	46092-1005	304332	poliert	8,50
Z 750 GP (KZ750R)	KZ750R	82	46092-1026	303132	schwarz	5,70	46092-1024	304112	schwarz	6,50
Z 750 Sport (L3) (4 Zyl.)	KZ750R	83	46092-1043	303262	schwarz	8,50	46092-1041	304252	schwarz	8,50
Z 750 Sport (L4) (4 Zyl.)	KZ750R	84	46092-1026	303132	schwarz	5,70	46092-1103	304102	schwarz	6,20
Z 750 LTD (H1) (4 Zyl.)	KZ750H	80	46092-1004	303142	poliert	5,70	46092-022	304132	poliert	6,50
Z 750 LTD (H2) (4 Zyl.)	KZ750H	81	46092-1012	303272	poliert	8,50	46092-022	304132	poliert	6,50
Z 750 LTD (H3) (4 Zyl.)	KZ750H	82	46092-1012	303272	poliert	8,50	46092-1005	304332	poliert	8,50
Z 750 LTD (Y1) (2 Zyl.)	KZ750Y	82	46092-1012	303272	poliert	8,50	46092-1005	304332	poliert	8,50
Z 750 LTD (K/Y2) (2 Zyl.)	KZ750K/Y	83	nicht im Progr.		poliert		46092-1041	304252	schwarz	8,50
ZR 7	ab 01	13236-1221	303182	poliert	16,50	46092-1162	304162	poliert	15,30	

BELEUCHTUNG, STURZTEILE

Hebel • Levers • Leviers

Fabrikat/ Modell	Bj.	Bremshebel Originalnummer	Cypacc- Art.-Nr.	Farbe	€	Kupplungshebel Originalnummer	Cypacc- Art.-Nr.	Farbe	€	
ZR 750 Zephyr	ZR750C	ab 91	13236-1221	303182	poliert	16,50	46076-1168/80	304262	poliert	23,90
ZXR 750 /R	ZX750H/J/K/L/M	89-95	13236-1185	303172	schwarz	16,50	13236-1186	304192	schwarz	17,90
ZX 7R	ZR750F	99-	13236-1221	303182	poliert	16,50	46092-1162	304162	poliert	15,30
ZX 7R	ZR750F	2001-	nicht im Progr.			13236-1186	304192	schwarz	17,90	
ZX 7 R/RR	ZX750N/P	ab 96	13236-1185	303172	schwarz	16,50	13236-1186	304192	schwarz	17,90
VN 800 Drifter	VN800C	ab 00	13236-1185	303172	schwarz	16,50	46052-1204	304362	in Vorb.	
VN 800 Vulcan/ Classic	VN800A/B	ab 96	46092-1172	303162	poliert	6,60	46092-1164	304142	poliert	8,20
GPZ 900 R (A1-6)	ZX900A	84-89	46092-1117	303102	schwarz	6,90	46092-1130	304182	schwarz	5,70
GPZ 900 R (A7-10)	ZX900A	90-93	13236-1185	303172	schwarz	16,50	13236-1186	304192	schwarz	17,90
Z 900/ Z1 A/B	Z1F	73-75	43029-003	301422	poliert	5,40	46092-016	304242	poliert	5,40
Z 900 (A4)	Z1F	76	43029-003	301422	poliert	5,40	46092-022	304132	poliert	6,50
ZX 9 R Ninja	ZX900B	95-97	13236-1185	303172	schwarz	16,50	13236-1186	304192	schwarz	17,90
ZX 9 R Ninja	ZX900D	98-99	13236-1310	303192	poliert	15,30	46076-1168/80	304262	poliert	23,90
ZX 9 R Ninja	ZX900E	ab 00	13236-1310	303192	poliert	15,30	46092-1211	304302	poliert	8,50
GPZ 1000 RX	ZXT00A	86-87	46092-1117	303102	schwarz	6,90	46092-1130	304182	schwarz	5,70
GTR 1000 (A1-6)	ZGT00A	86-91	46092-1117	303102	schwarz	6,90	46092-1130	304182	schwarz	5,70
GTR 1000 (A7-11)	ZGT00A	92-96	13236-1185	303172	schwarz	16,50	13236-1186	304192	schwarz	17,90
Z 1 R (Z1F-B)	KZT00D	78-79	46092-1003	303302	poliert	8,50	46092-022	304132	poliert	6,50
Z 1000	ZRT00A	ab 03	13236-1310	303192	poliert	15,30	46092-1211	304302	poliert	8,50
Z 1000 (A1/2)	KZT00A	77-78	43029-003	301422	poliert	5,40	46092-022	304132	poliert	6,50
Z 1000 J	KZT00J	81-82	46092-1004	303142	poliert	5,70	46092-1005	304332	poliert	8,50
Z 1000 LTD	KZT00K	81	46092-1012	303272	poliert	8,50	46092-1005	304332	poliert	8,50
Z 1000 MK2 (A3/4)	KZT00A	79-80	46092-1002	303312	poliert	6,50	46092-022	304132	poliert	6,50
Z 1000 R	KZT00R	83	46092-1026	303132	schwarz	5,70	46092-1024	304112	schwarz	6,50
Z 1000 ST	KZT00E	79-80	46092-1004	303142	poliert	5,70	46092-022	304132	poliert	6,50
ZX 10	ZXT00B	88-90	13236-1185	303172	schwarz	16,50	13236-1186	304192	schwarz	17,90
GPZ 1100 Unitrak	ZXT10A	83-85	46092-1027	303152	schwarz	9,40	46092-1050	304172	schwarz	5,70
GPZ 1100 Horizont	ZXT10E	95-96	13236-1185	303172	schwarz	16,50	13236-1186	304192	schwarz	17,90
Z 1100 GP (B2)	KZT10B	82	46092-1026	303132	schwarz	5,70	46092-1024	304112	schwarz	6,50
Z 1100 ST	KZT10A	81-83	46092-1004	303142	poliert	5,70	46092-1005	304332	poliert	8,50
ZR 1100 Zephyr	ZRT10A	91-95	13236-1221	303182	poliert	16,50	13236-1282	304202	poliert	15,90
ZRX 1100	ZRT10C	ab 97	13236-1185	303172	schwarz	16,50	13236-1186	304192	schwarz	17,90
ZZR 1100	ZXT10C/D	ab 90	13236-1185	303172	schwarz	16,50	13236-1186	304192	schwarz	17,90
ZRX 1200 S/R	ZRT20A	ab 01	13236-1221	303182	poliert	16,50	13236-1282	304202	poliert	15,90
ZX 12 R	ZXT12A	ab 00	13236-1310	303192	poliert	15,30	46092-1211	304302	poliert	8,50
ZZ-R 1200		ab 02	13236-1185	303172	schwarz	16,50	13236-1186	304192	schwarz	17,90
Z 1300 (A1-5)	KZT30A	79-83	46092-1004	303142	poliert	5,70	46092-1005	304332	poliert	8,50
ZG 1300 (A1-5)	ZGT30A	84-89	46092-1026	303132	schwarz	5,70	46092-1101	304342	schwarz	11,90
VN 1500 Classic	VNT50D	96-98	13236-1315	303202	poliert	15,30	13236-1282	304202	poliert	15,90
VN 1500 Drifter	VNT50J	ab 01	13236-1315	303202	poliert	15,30	13236-1316	304212	poliert	15,90
VN 1500 Mean Streak		ab 02	13236-1315	303202	poliert	15,30	13236-1316	304212	poliert	15,90
VN 1500 Nomad		ab 99	13236-1315	303202	poliert	15,30	13236-1316	304212	poliert	15,90
VN 1500 Vulcan	VNT50A/B/C	87-95	46092-1172	303162	poliert	6,60	46092-1173	308212	poliert	6,50
VN 1500 Vulcan Classic		ab 99	13236-1315	303202	poliert	15,30	13236-1316	304212	poliert	15,90
VN 1600 Vulcan		ab 03	13236-1315	303202	poliert	15,30	13236-1316	304212	poliert	15,90
*304272 auch lieferbar als Hebel ohne Einsteller						46092-1161	304152	schwarz	8,20	
*304262 auch lieferbar als Hebel ohne Einsteller						46092-1162	304162	poliert	15,30	
KTM										
DOMINO Kupplung (Seil)		96-98				546-02-055-200	312102	poliert	9,80	
BREMBO Kupplung (Hydraulik)		ab 03				590-02-031-000	312112	poliert	13,90	
BREMBO Bremse (Hydraulik)		96-04	502-13-020-000	310102	9,80	nicht im Progr.				
65/85 SX	2 Takt	ab 03	470-13-002-000	310112	poliert	in Vorb.	546-02-031-00	312122	poliert	in Vorb.
125/200 EGS/EXC/EU/SX	2 Takt	98				503-02-031-00	312132	poliert	13,90	
125/200 EGS/EXC/EU/SX	2 Takt	99	503-13-002-000	310122	poliert	9,80	503-02-031-00	312132	poliert	13,90
125/200 EGS/EXC/EU/SX	2 Takt	00	503-13-002-000	310122	poliert	9,80	503-02-031-00	312132	poliert	13,90
125 LC2 / 360 MXC	2 Takt	96-98				546-02-055-200	312102	poliert	9,80	
250/300/380/400 EXC/MXC/SX	2 Takt	99-00	503-13-002-000	310122	poliert	9,80	546-02-055-200	312132	poliert	13,90
250/350/450/525 EXC/SXC/SX	4 Takt	ab 03	503-13-002-100	310132	poliert	9,80	546-02-031-00	312122	poliert	in Vorb.
625/640 LC4/SXC/SM/DUKE 2	4 Takt	03-04	503-13-002-100	310132	poliert	9,80	546-02-031-00	312122	poliert	in Vorb.
660 SMC/SMS/Rallye	4 Takt	03-04				546-02-031-00	312122	poliert	in Vorb.	
SUZUKI										
AP 50/ A 50		75-78	57421-27210	305232	poliert	5,40	57621-27210	306262	poliert	5,40
GT 50/ TS 50		77-81	57421-27210	305232	poliert	5,40	57621-27210	306262	poliert	5,40
RV 50	RV50	73-77	57421-27210	305232	poliert	5,40	57621-27210	306262	poliert	5,40
RM 65/ RM100		ab 03	13236-1346	303222	poliert	9,20	46092-1165	304222	poliert	8,50
GT 80 E/L	GT80	81-82	57421-13001	305192	schwarz	5,90	nicht im Progr.			
RG 80 Gamma	NC11A	85-96	57421-13001	305192	schwarz	5,90	nicht im Progr.			
RV 90		75-77	57421-27210	305232	poliert	5,40	57621-27210	306262	poliert	5,40
RM 100/125/250/400		75-81	57420-11012	305242	poliert	5,40	57620-45010	306272	poliert	5,40
RM/DR 125/ RM 250		85-88	57421-14500	305252	schwarz	8,50	57620-14310	306282	poliert	8,50
RV 125	RV125	73-77	57420-18602	305202	poliert	7,00	nicht im Progr.			



BELEUCHTUNG, STURZTEILE

Hebel • Levers • Leviers

Fabrikat/ Modell	Bj.	Bremshebel Originalnummer	Cypacc- Art.-Nr.	Farbe	€	Kupplungshebel Originalnummer	Cypacc- Art.-Nr.	Farbe	€	
DR 125 SE	SF44A	ab 94	57421-03D00	303292	poliert	6,20	57620-14300	306292	poliert	9,80
GN 125	NF41A	ab 91	57421-13001	305192	schwarz	5,90	57620-49101	306102	schwarz	6,50
GZ 125 Marauder	AP	ab 99	57420-32C00	305132	poliert	15,30	57621-33E00	306232	poliert	6,00
RM 125/250		ab 97	53175-KCE-690	301302	poliert	9,80	57621-28C00	306302	poliert	7,90
RV 125		73-77	57421-27210	305232	poliert	5,40	57621-27210	306262	poliert	5,40
TU 125 X	AZ	97-00	57420-32C00	305132	poliert	15,30	57621-33E00	306232	poliert	6,00
TS 125	TS125	73-78	57420-18602	305202	poliert	7,00	nicht im Progr.			
TS 125 C2		78	57420-18602	305202	poliert	7,00	57620-29400	306112	poliert	5,70
TS 125		ab 80	57420-26500	305102	schwarz	6,00	57620-26500	306122	schwarz	5,90
TS 125 ER		79	57420-18602	305202	poliert	7,00	57620-29400	306112	poliert	5,70
TS 185		ab 80	57420-26500	305102	schwarz	6,00	57620-26500	306122	schwarz	5,90
VL 125 Intruder		99-	nicht im Progr.				57621-33E00	306232	poliert	6,00
DR 250 S	SG/SJ42A	82-87	57420-26500	305102	schwarz	6,00	57620-49101	306102	schwarz	6,50
GN 250	NJ42A	82-84	57420-26500	305102	schwarz	6,00	57620-49101	306102	schwarz	6,50
GN 250	NJ42A	85-93	57420-49101	305112	schwarz	6,20	57620-49101	306102	schwarz	6,50
GN 250	NJ42A	ab 94	57420-01D00	305122	schwarz	6,20	57620-49101	306102	schwarz	6,50
GSX 250 E	GS25X	80-82	57420-26500	305102	schwarz	6,00	57620-49101	306102	schwarz	6,50
GT 250	GT250	73-78	57420-11320	305142	poliert	5,50	57620-45010	306272	poliert	5,40
GT 250	X7	79-81	57420-26500	305102	schwarz	6,00	57620-49101	306102	schwarz	6,50
GZ 250 Marauder	AR	ab 99	57420-32C00	305132	poliert	15,30	57621-33E00	306232	poliert	6,00
RG 250 Gamma	GJ21A	83-89	57420-45500	305152	schwarz	5,50	57620-49111	304112	schwarz	6,50
RGV 250 Gamma	VJ21A/VJ22B	89-93	57420-32C00	305132	poliert	15,30	57620-27A31	306142	poliert	5,70
RM 250		93-95	57421-27000	305262	poliert	8,50	57620-26500	306122	schwarz	5,90
TU 250 X		97-00	57420-32C00	305132	poliert	15,30	57621-33E00	306232	poliert	6,00
TS 250	TS250	71-76	57420-18602	305202	poliert	7,00	nicht im Progr.			
TS 250	TS2504	77-78	57420-18602	305202	poliert	7,00	nicht im Progr.			
TS 250 ER	TS2504	79	57420-18602	305202	poliert	7,00	57620-29400	306112	poliert	5,70
TS 250 X	SJ11B	80-86	57420-26500	305102	schwarz	6,00	57620-26500	306122	schwarz	5,90
TS 250 X	SJ11D	87-89	57421-13A10	305272	schwarz	8,50	57620-49101	306102	schwarz	6,50
DR 350 S/SE/SH	SK42B	ab 90	57421-03D00	303292	poliert	6,20	57620-14300	306292	poliert	9,80
SP 370	SP370	78-79	57420-18602	305202	poliert	7,00	57620-29400	306112	poliert	5,70
GT 380	GT380	ab 76	57420-11320	305142	poliert	5,50	57620-45010	306272	poliert	5,40
DR 400 S	DR400	80-81	nicht im Progr.				57620-26500	306122	schwarz	5,90
DR-Z 400	BE	ab 00	57421-03D00	303292	poliert	6,20	57620-14300	306292	poliert	9,80
GS 400 E	GS400	77-79	57420-49101	305112	schwarz	6,20	57620-49101	306102	schwarz	6,50
GSF 400 Bandit	GK75B	ab 91	57420-32C00	305132	poliert	15,30	57620-27A31	306142	poliert	5,70
GSX 400 E/L	GS40X	80-83	57420-49101	305112	schwarz	6,20	57620-49101	306102	schwarz	6,50
GSX 400 E/S	GK53C	82-87	57420-49101	305112	schwarz	6,20	57620-49101	306102	schwarz	6,50
GSX 400 F Katana	GS40XF	81-84	57420-49101	305112	schwarz	6,20	57620-49101	306102	schwarz	6,50
GSX-R 400	GK76A	ab 91	57420-32C00	305132	poliert	15,30	57620-27A30	306142	poliert	5,70
GS 450 E/L/S/T	GL51D/F	80-88	57420-49101	305112	schwarz	6,20	57620-49101	306102	schwarz	6,50
DR 500 S	DR500	81	57420-26500	305102	schwarz	6,00	57620-26500	306122	schwarz	5,90
DR 500 S	DR500	82-84	57420-26500	305102	schwarz	6,00	57620-49101	306102	schwarz	6,50
GS 500 E	GM51B	bis 89	57420-01D00	305122	schwarz	6,20	57620-33410	306152	schwarz	5,70
GS 500 E	GM51B	90-00	57420-32C00	305132	poliert	15,30	57620-01D00	306162	poliert	6,20
GS 500 E	BK	ab 01	57420-33E00	305282	poliert	39,90	57620-01D00	306162	poliert	6,20
GT 500	GT500	75-77	57420-11320	305142	poliert	5,50	57620-45010	306272	poliert	5,40
RG 500 Gamma	HM31A	86-89	57420-49101	305112	schwarz	6,20	57620-49111	304112	schwarz	6,50
GS 550 D/E/L/T	GS550	77-82	57420-39100	305142	poliert	5,50	57620-45010	306272	poliert	5,40
GSX 550 E/EF/ES/EU	GN71D	83-87	57420-45500	305152	poliert	5,50	57620-33410	306152	schwarz	5,70
DR 600 S/R	SN41A/D	85-89	57421-13A10	305272	schwarz	8,50	57620-49101	306102	schwarz	6,50
GSF 600 N/S Bandit	GN77B	95-99	57420-32C00	305132	poliert	15,30	57620-01D00	306162	poliert	6,20
GSF 600 N/S Bandit	A8	ab 00	57420-33E00	305282	poliert	39,90	57620-01D00	306162	poliert	6,20
GSX 600 F	GN72B	88	57420-19C00	305162	poliert	6,80	57620-19C01	306142	poliert	5,70
GSX 600 F	GN72B	89-97	57420-32C00	305132	poliert	15,30	57620-19C01	306142	poliert	5,70
GSX 600 F	AJ	ab 98	57420-32C00	305132	poliert	15,30	57620-27A31	306142	poliert	5,70
GSX-R 600 SRAD	AD	97-00	57420-32C00	305132	poliert	15,30	57621-33E00	306232	poliert	6,00
GSX-R 600	BG	01-03	57420-33E00	305282	poliert	39,90	57621-33E00	306232	poliert	6,00
GSX-R 600	B2	04-05	57300-29G00	305282	poliert	39,90	57621-40F00	306362		in Vorb.
RF 600 R	GN76B	ab 93	57420-32C00	305132	poliert	15,30	57620-19C01	306142	poliert	5,70
VS 600 Intruder (alu)	VN51B	ab 95	57420-24B00	305172	poliert	7,00	57620-38A00	306172	poliert	6,20
VS 600 Intruder (chrom)	VN51B	ab 95	57420-38B10	305212	Chrom	11,80	57620-38B01	306212	Chrom	11,80
AN 650 Burgman		ab 03	57420-33E00	305282	poliert	39,90	57500-10G00	306312	poliert	39,90
DR 650 R/RE	SP41/44/45B	90-95	57421-13001	305192	schwarz	5,90	57620-14310	306282	schwarz	8,50
DR 650 RS/RSE	SP42/43B	90-96	57421-13001	305192	schwarz	5,90	57620-14310	306282	schwarz	8,50
DR 650 SE	SP46B	ab 96	57421-13001	305192	schwarz	5,90	57620-49111	304112	schwarz	6,50
GR 650	GP51A	83-85	57420-49101	305112	schwarz	6,20	57620-49101	306102	schwarz	6,50
GS 650 G Katana	GS650G	81-85	57420-49101	305112	schwarz	6,20	57620-49101	306102	schwarz	6,50
LS 650 Savage	NP41B	86-88	57420-19C00	305162	poliert	6,80	57620-38A00	306172	poliert	6,20
LS 650 Savage	NP41B	ab 89	57420-24B00	305172	poliert	7,00	57620-24B00	304142	poliert	8,20
SV 650 N/S	AV	ab 99	57420-33E00	305282	poliert	39,90	57620-27A31	306142	poliert	5,70
XF 650	AC211	97	57420-32C00	305132	poliert	15,30	nicht im Progr.			
DR 750 Big / S	SR41B	88-89	57421-13001	305192	schwarz	5,90	57620-49111	304112	schwarz	6,50

BELEUCHTUNG, STURZTEILE

Hebel • Levers • Leviers

Fabrikat/ Modell	Bj.	Bremshebel Originalnummer	Cypacc- Art.-Nr.	Farbe	€	Kupplungshebel Originalnummer	Cypacc- Art.-Nr.	Farbe	€	
GS 750 D/E/L	GS750	77-79	57420-39100	305142	poliert	5,50	57620-45010	306272	poliert	5,40
GSX 750	AE	ab 97	57420-32C00	305132	poliert	15,30	57620-01D00	306162	poliert	6,20
GSX 750 E/L	GS75X	80-82	57420-49101	305112	schwarz	6,20	57620-49101	306102	schwarz	6,50
GSX 750 S Katana	GR71A	81-85	57420-49101	305112	schwarz	6,20	57620-49111	304112	schwarz	6,50
GSX 750 EF/ES	GR72A	83-87	57420-45500	305152	schwarz	5,50	57620-49101	306102	schwarz	6,50
GSX 750 F	GR78A	89-98	57420-32C00	305132	poliert	15,30	57620-19C01	306142	poliert	5,70
GSX-R 750	GR75A	85-87	57420-05A10	305182	schwarz	6,50	57620-08A00	306192	schwarz	7,00
GSX-R 750	GR77B	88-89	57420-17C00	305292	poliert	9,20	57620-27A30	306142	poliert	5,70
GSX-R 750	GR7AB	90-91	57420-32C00	305132	poliert	15,30	57620-27A30	306142	poliert	5,70
GSX-R 750 R	GR79B	89-91	57420-32C00	305132	poliert	15,30	57620-27A30	306142	poliert	5,70
GSX-R 750 W	GR7BB	92-95	57420-32C00	305132	poliert	15,30	57620-27A31	306142	poliert	5,70
GSX-R 750 W SRAD	GR7DB	96-97	57420-32C00	305132	poliert	15,30	57621-33E00	306232	poliert	6,00
GSX-R 750 W SRAD	GR7DB	98-99	57420-33E00	305282	poliert	39,90	57621-33E00	306232	poliert	6,00
GSX-R 750	BD	00-03	57420-33E00	305282	poliert	39,90	57621-33E00	306232	poliert	6,00
GSX-R 750	B3	04-05	57300-29G00	305282	poliert	39,90	57621-40F00	306362	in Vorb.	
GT 750	GT750	73-77	57420-39100/11300	305142	poliert	5,50	57620-45010	306272	poliert	5,40
VS 750 Intruder	VR51B	85-88	57420-19C00	305162	poliert	6,80	57620-38A00	306172	poliert	6,20
VS 750 Intruder (alu)	VR51B	89-91	57420-24B00	305172	poliert	7,00	57620-38A00	306172	poliert	6,20
VS 750 Intruder (chrom)	VR51B	89-91	57420-38B10	305212	Chrom	11,80	57620-38B01	306212	Chrom	11,80
VL 800		2001	57700-41E00	305313	in Vorb.		57620-24B01	306242	poliert	6,50
DR 800 Big	SR42/43B	ab 90	57421-13001	305192	schwarz	5,90	57620-49111	304112	schwarz	6,50
VS 800 GL/ Intruder (alu)	VS52B	ab 92	57420-24B00	305172	poliert	7,00	57620-38A00	306172	poliert	6,20
VS 800 GL/ Intruder (chrom)	VS52B	ab 92	57420-38B10	305212	Chrom	11,80	57620-38B01	306212	Chrom	11,80
VX 800	VS51B	90-96	57420-32C00	305132	poliert	15,30	57620-45C00	306322	poliert	12,90
VZ 800 Marauder	AF	ab 96	57420-32C00	305132	poliert	15,30	57620-24B00	304142	poliert	8,20
GS 850 G/ GL	GS850/GS72A	79-86	57420-49101	305112	schwarz	6,20	57620-49101	306102	schwarz	6,50
RF 900 R/RS2	GT73B	ab 94	57420-32C00	305132	poliert	15,30	57620-40C00	306202	poliert	6,70
DL 1000 V-Strom	BS	ab 02	57420-33E00	305282	poliert	39,90	57621-02F00	306222	poliert	15,90
GS 1000 E/G/H/L/S	GS1000	78-79	57420-39100	305142	poliert	5,50	57620-45010	306272	poliert	5,40
GS 1000 G/GL	GS100G	80-81	57420-49101	305112	schwarz	6,20	57620-49101	306102	schwarz	6,50
GSX-R 1000	BL/BZ	01-04	57420-33E00	305303	poliert	39,90	57621-33E00	306232	poliert	6,00
GSX-R 1000		05-06	57300-29G00	305282	poliert	39,90	57621-41600	306352	in Vorb.	
SV 1000	BX	ab 03	57420-33E00	305282	poliert	39,90	57500-24F00	306222	poliert	15,90
TL 1000 R	AM	ab 98	57420-33E00	305282	poliert	39,90	57621-02F00	306222	poliert	15,90
TL 1000 S	AG	ab 97	57420-32C00	305132	poliert	15,30	57500-02FA0	306252	poliert	15,30
GS 1100 G	GU73A	84-85	57420-49101	305112	schwarz	6,20	57620-49111	304112	schwarz	6,50
GSX 1100 E/S/L/G/Katana	GS110X	81-82	57420-49101	305112	schwarz	6,20	57620-49101	306102	schwarz	6,50
GSX 1100 E/EF/ES	GV71C	84-87	57420-45500	305152	schwarz	5,50	57620-49101	306102	schwarz	6,50
GSX 1100 F	GV72C	88	57420-05A10	305182	schwarz	6,50	57461-48B00	306332	schwarz	9,80
GSX 1100 F	GV72C	ab 89	57420-48B00	305302	schwarz	12,90	57461-48B00	306332	schwarz	9,80
GSX 1100 G (Kardan)	GV74A	ab 91	57420-32C00	305132	poliert	15,30	57620-40C00	306202	poliert	6,70
GSX-R 1100	GU74C	86-88	57420-05A10	305182	schwarz	6,50	57620-08A00	306192	schwarz	7,00
GSX-R 1100	GV73C	89-92	57420-32C00	305132	poliert	15,30	57620-40C00	306202	poliert	6,70
GSX-R 1100 W	GU75C	ab 93	57420-32C00	305132	poliert	15,30	57620-40C00	306202	poliert	6,70
GSF 1200 N/S Bandit	GV75A	96-00	57420-32C00	305132	poliert	15,30	57620-38A00	306172	poliert	6,20
GSF 1200 N/S Bandit	A9	ab 01	57420-33E00	305282	poliert	39,90	57500-24F00	306222	poliert	15,90
GSX 1200 Inazuma	A3	ab 98	57420-33E00	305282	poliert	39,90	57500-24F00	306222	poliert	15,90
GSX-R 1300 Hayabusa	A1	ab 99	57420-33E00	305282	poliert	39,90	57500-24F00	306222	poliert	15,90
GSX 1400	BN	ab 01	57420-33E00	305282	poliert	39,90	57500-24F00	306222	poliert	15,90
VS 1400 GL/ Intruder (alu)	VX51L	ab 87	57420-24B00	305172	poliert	7,00	57620-38A00	306172	poliert	6,20
VS 1400 GL/ Intruder (chrom)	VX51L	ab 87	57420-38B10	305212	Chrom	11,80	57620-38B01	306212	Chrom	11,80
VL 1500	AL	ab 98	57420-32C00	305132	poliert	15,30	57620-38A00	306172	poliert	6,20
*305132 auch lieferbar als Hebel ohne Einsteller							57420-32C00	306342	poliert	11,90
TRIUMPH										
TT 600		00-03	5EB-83922-01	307272	poliert	15,30				
600 Daytona		ab 03	5EB-83922-01	307272	poliert	15,30	T2046511	312142	poliert	9,90
750 Daytona		91-92	364-87382-50	307232	poliert	18,90	13236-1282	304202	poliert	15,90
900 Daytona; Super 3		ab 93	364-87382-50	307232	poliert	18,90	13236-1282	304202	poliert	15,90
900 Speed Triple		ab 94	364-87382-50	307232	poliert	18,90	13236-1282	304202	poliert	15,90
900 Sprint		ab 93	364-87382-50	307232	poliert	18,90	13236-1282	304202	poliert	15,90
900 Trophy		ab 91	364-87382-50	307232	poliert	18,90	13236-1282	304202	poliert	15,90
955 i Daytona		ab 97	364-87382-50	307232	poliert	18,90	13236-1282	304202	poliert	15,90
1000 Daytona		91-92	364-87382-50	307232	poliert	18,90	13236-1282	304202	poliert	15,90
1200 Daytona		ab 93	364-87382-50	307232	poliert	18,90	13236-1282	304202	poliert	15,90
1200 Trophy		ab 91	364-87382-50	307232	poliert	18,90	13236-1282	304202	poliert	15,90
YAMAHA										
FS 1G (50ccm)	FS1	75-76	137-83922-38	307282	poliert	15,90	137-83912-38	308102	poliert	4,80
FS1 50		77-78	341-83922-00	307112	poliert	5,90	214-83912-00	308122	poliert	6,50
DT 50/80 MX	13N/5J1	82-87	137-83922-38	307282	poliert	15,90	137-83912-38	308102	poliert	4,80
DT 50/80 R/LCII	3MN/53V	85-90	43F-83922-00	307102	schwarz	5,70	5Y1-83912-00	308112	schwarz	5,70
RD 50 M	13M/2E0	80-82	3M5-83922-00	307292	poliert	17,90	214-83912-00	308122	poliert	6,50

SCOOTER

BELEUCHTUNG, STURZTEILE

Hebel • Levers • Leviers

Fabrikat/ Modell	Bj.	Bremshebel Originalnummer	Cypacc- Art.-Nr.	Farbe	€	Kupplungshebel Originalnummer	Cypacc- Art.-Nr.	Farbe	€	
DT 80 LC	37A	83-84	5Y1-83922-00	307122	schwarz	5,90	5Y1-83912-00	308112	schwarz	5,70
RD 80 LC/LCII	10X/30W	82-85	4L0-83922-00	307302	schwarz	6,20	10W-83912-00	308132	schwarz	5,90
RD 80 MX	5G1	81-82	3M5-83922-00	307292	schwarz	17,90	2H0-83912-20	308152	schwarz	5,90
YZ 80/100/125/250/490		78-84	23X-83922-00	307312	poliert	8,50	23X-83912-00	308282	poliert	8,50
YZ 80/100/125/250/490		86-89	55Y-83922-00	307322	poliert	6,20	23X-83912-00	308282	poliert	8,50
YZ 80/125/250/400		96-00	4SS-83922-00	307332	poliert	8,50	4GY-83912-00	308292	poliert	7,90
YZ 80/125		ab 01	13236-1346	303222	poliert	9,20	5HD-83912-00	308302	poliert	8,50
YZ 85		ab 03	13236-1346	303222	poliert	9,20	5MV-83912-00	308312	poliert	9,80
DT 125 E	1G0	76-79	583-83922-00	305242	poliert	5,40	583-83912-00	306272	poliert	5,40
DT 125 LC	10V	82-85	5Y1-83922-00	307122	schwarz	5,90	5Y1-83912-00	308112	schwarz	5,70
DT 125 R	4BL/3RM	ab 91	3RN-83922-00	307342	Chrom	14,90	3RN-83912-00	308322	poliert	7,90
IT 125/175/250/465/490		79-83	23X-83922-00	307312	poliert	8,50	23X-83912-00	308282	poliert	8,50
RD 125 LC	10W	82-84	4L0-83922-00	307302	schwarz	6,20	10W-83912-00	308132	schwarz	5,90
RD 125 DX	AS.32R6	75-79	341-83922-00	307112	poliert	5,90	214-83912-00	308122	poliert	6,50
TW 125 Trailway	5EK	ab 99	55Y-83922-00	307322	poliert	6,20	4GY-83912-00	308292	poliert	7,90
XV 125 Virago (chrom)	5AJ	ab 97	57A-83922-01	307342	Chrom	14,90	57A-83912-01	308332	Chrom	14,90
XV 125 Virago (Alu)	5AJ	ab 97	2W1-83922-00	307142	poliert	6,90	2GV-83912-00	308142	poliert	5,90
XVS 125 Drag-Star (chrom)		ab 01	57A-83922-01	307342	Chrom	14,90	57A-83912-01	308332	Chrom	14,90
XVS 125 Drag-Star (alu)		ab 01	2W1-83922-00	307142	poliert	6,90	2GV-83912-00	308142	poliert	5,90
DT 175 Trommelbremse		75-76	583-83922-00	305242	poliert	5,40	583-83912-00	306272	poliert	5,40
DT 175 MX Scheibenbremse	2K4	78-81	2H0-83922-00	307152	schwarz	5,90	2H7-83912-00	308152	schwarz	5,90
RD 200 Trommelbremse	397	74-76	583-83922-00	305242	poliert	5,40	583-83912-00	306272	poliert	5,40
DT 250 Trommelbremse	512	75-77	583-83922-00	305242	poliert	5,40	583-83912-00	306272	poliert	5,40
DT 250 MX Scheibenbremse	1R7	78-81	2H0-83922-00	307152	schwarz	5,90	2H7-83912-00	308152	schwarz	5,90
FZR 250 Fazer		83-89	nicht im Progr.		schwarz		1HX-83912-00	308342	schwarz	8,50
RD 250 /DX	522/1A2	73-79	341-83922-00	307112	poliert	5,90	583-83912-00	306272	poliert	5,40
RD 250 LC	4L1	80-82	4L0-83922-00	307302	schwarz	6,20	4L0-83912-00	308352	schwarz	6,20
TDR 250	3CK	88-93	43F-83922-00	307102	schwarz	5,70	5Y1-83912-00	308112	schwarz	5,70
IT 250		80-82	23X-83922-00	307312	poliert	8,50	23X-83912-00	308282	poliert	8,50
TZR 250	2MA/2XW	87-90	31A-83922-00	307162	schwarz	5,90	29L-83912-00	308162	schwarz	5,90
WR 250 F/ YZ 250		ab 01	13236-1346	303222	poliert	9,20	5MV-83912-00	308312	poliert	9,80
XS 250	1U5	78-82	2J2-83922-00	307132	schwarz	6,90	2H7-83912-00	308152	schwarz	5,90
XT 250	3Y3	80-90	2H0-83922-00	307152	schwarz	5,90	2H0-83912-20	308152	schwarz	5,90
XV 250 Virago (chrom)	3LS/3LW	ab 89	57A-83922-01	307342	Chrom	14,90	57A-83912-01	308332	Chrom	14,90
XV 250 Virago (alu)	3LS/3LW	ab 89	2W1-83922-00	307142	poliert	6,90	2GV-83912-00	308142	poliert	5,90
XV 250	3LW6	96	nicht im Progr.				1AA-83912-00	308172	poliert	6,50
RD 350	521	73-75	341-83922-00	307112	poliert	5,90	583-83912-00	306272	poliert	5,40
RD 350 LC	4L0	80-82	4L0-83922-00	307302	schwarz	6,20	4L0-83912-00	308352	schwarz	6,20
RD 350 LC YPVS	31K	83-84	31A-83922-00	307162	schwarz	5,90	29L-83912-00	308162	schwarz	5,90
RD 350 LC F	31K/57V/1AF	85	36Y-83922-00	307172	schwarz	5,90	31A-83912-00	308182	schwarz	5,90
RD 350 LC N	31K/1FG/1JG	85	36Y-83922-00	307172	schwarz	5,90	29L-83912-00	308162	schwarz	5,90
RD 350 LC F/N	1WX/1WW	86-90	36Y-83922-00	307172	schwarz	5,90	29L-83912-00	308162	schwarz	5,90
TT 350	1TJ	86-89	55Y-83922-00	307322	poliert	6,20	23X-83912-00	308282	poliert	8,50
XT 350	55V/59Y/3YT	86-91	43F-83922-00	307102	schwarz	5,70	5Y1-83912-00	308112	schwarz	5,70
XS 360	1U4	77-78	2J2-83922-00	307132	schwarz	6,90	2H7-83912-00	308152	schwarz	5,90
DT 400 Trommelbremse	513	75-76	233-83922-30	305242	poliert	5,40	583-83912-00	306272	poliert	5,40
DT 400 MX Scheibenbremse	1R6	77-80	2H0-83922-00	307152	schwarz	5,90	2H7-83912-00	308152	schwarz	5,90
FZ 400 R		87-88	36Y-83922-00	307172	schwarz	5,90	29L-83912-00	308162	schwarz	5,90
FZR 400		88-90	1FK-83922-00	307182	poliert	6,50	3HE-83912-00	308362	poliert	8,50
FZR 400 RR	3TJ/4DX	90-92	3TJ-83922-00	307232	poliert	18,90	3HE-83912-00	308362	poliert	8,50
RD 400 /DX	1A3	76-79	341-83922-00	307112	poliert	5,90	583-83912-00	306272	poliert	5,40
XS 400 / SE	2A2/4G5	78-82	2J2-83922-00	307132	schwarz	6,90	2H7-83912-00	308152	schwarz	5,90
XS 400 DOHC	12E/12F	82-87	2J2-83922-00	307132	schwarz	6,90	11U-83912-00	308372	schwarz	8,50
WR 426 F/ YZ 426		ab 01	13236-1346	303222	poliert	9,20	5MV-83912-00	308312	poliert	9,80
WR 450 F/ YZ 450		ab 03	13236-1346	303222	poliert	9,20	5MV-83912-00	308312	poliert	9,80
RD 500 LC YPVS	47X/1GE	84-87	36Y-83922-00	307172	schwarz	5,90	29L-83912-00	308162	schwarz	5,90
SR 500 Scheibenbremse	2J2/48T	78-91	2J2-83922-00	307132	schwarz	6,90	2H7-83912-00	308152	schwarz	5,90
SR 500 Trommelbremse	48T/3EB	88-94	2H0-83922-00	307152	schwarz	5,90	2H7-83912-00	308152	schwarz	5,90
XT 500	alle	76-89	2H0-83922-00	307152	schwarz	5,90	2H0-83912-20	308152	schwarz	5,90
XV 500 SE	26R	83	2J2-83922-00	307132	schwarz	6,90	10M-83912-00	308382	schwarz	8,50
XV 535 Virago (chrom)	2YL/3BR/4MC	ab 88	57A-83922-01	307342	Chrom	14,90	57A-83912-01	308332	Chrom	14,90
XV 535 Virago (alu)	2YL/3BR/4MC	ab 88	2W1-83922-00	307142	poliert	6,90	2GV-83912-00	308142	poliert	5,90
XJ 550	4V8/27A	80-83	2J2-83922-00	307132	schwarz	6,90	2H7-83912-00	308152	schwarz	5,90
XT 550	5Y3	82-83	5Y1-83922-00	307122	schwarz	5,90	5Y1-83912-00	308112	schwarz	5,70
XZ 550	11U	82-87	2J2-83922-00	307132	schwarz	6,90	11U-83912-00	308372	schwarz	8,50
FZR 600	3HE/3RG/3RH	89-93	1FK-83922-00	307182	poliert	6,50	3HE-83912-00	308362	poliert	8,50
FZR 600 R	4JH/4MH	94-95	3TJ-83922-00	307232	poliert	18,90	3LN-83912-00	308222	poliert	6,50
FZS 600 Fazer	RJ021/5DM	ab 98	3TJ-83922-00	307232	poliert	18,90	3YX-83912-00	308192	poliert	6,50
SRX 600	1XM/1XL	86-87	36Y-83922-00	307172	schwarz	5,90	31A-83912-00	308182	schwarz	5,90
TT 600	36A	83-84	23X-83922-00	307312	poliert	8,50	23X-83912-00	308282	poliert	8,50
TT 600	49X/2JT	85-89	55Y-83922-00	307322	poliert	6,20	23X-83912-00	308282	poliert	8,50
TT 600 E/S	4GV/4LW	ab 93	4GV-83922-00	307352	schwarz	9,90	3FA-83912-00	308392	schwarz	6,90
XJ 600	51J/3KM/3KN	84-91	36Y-83922-00	307172	schwarz	5,90	31A-83912-00	308182	schwarz	5,90

BELEUCHTUNG, STURZTEILE

Hebel • Levers • Leviers

Fabrikat/ Modell	Bj.	Bremshebel Originalnummer	Cypacc- Art.-Nr.	Farbe	€	Kupplungshebel Originalnummer	Cypacc- Art.-Nr.	Farbe	€	
XJ 600 S/N Diversion	4BR/4EB	92-95	3YX-83922-00	307192	poliert	8,70	3YX-83912-00	308192	poliert	6,50
XJ 600 S/N Diversion	4BR/4EB	ab 96	3YX-83922-00	307192	poliert	8,70	4KM-83912-00	308192	poliert	6,50
XT 600	43F/49H	84-86	43F-83922-00	307102	schwarz	5,70	5Y1-83912-00	308112	schwarz	5,70
XT 600 H/N	2KF/2NF	87-89	1KH-83922-00	307202	schwarz	6,50	5Y1-83912-00	308112	schwarz	5,70
XT 600 E/K	3TB/3UW/4AE	ab 90	3YR-83922-00	307202	schwarz	6,50	5Y1-83912-00	308112	schwarz	5,70
XT 600 Z Tenere	34L/55W	83-85	43F-83922-00	307102	schwarz	5,70	5Y1-83912-00	308112	schwarz	5,70
XT 600 Z Tenere	1VJ/3AJ	86-90	1KH-83922-00	307202	schwarz	6,50	5Y1-83912-00	308112	schwarz	5,70
YX 600 Radian		86-88	36Y-83922-00	307172	schwarz	5,90	31A-83912-00	308182	schwarz	5,90
YZF R6	RJ03	ab 99	5EB-83922-01	307272	poliert	15,30	5EB-83912-01	308402	poliert	8,50
YZF 600 Thundercat	4TV	ab 96	4SV-83922-00	307232	poliert	18,90	3LN-83912-00	308222	poliert	6,50
XJ 650	4K0	80-83	2J2-83922-00	307132	schwarz	6,90	2H7-83912-00	308152	schwarz	5,90
XS 650 /SE	447/3L1	77-83	2J2-83922-00	307132	schwarz	6,90	2H7-83912-00	308152	schwarz	5,90
XVS 650 Dragstar	VMZ	ab 97	5BN-83922-00	307362	poliert	14,90	5BN-83912-00	308242	poliert	6,50
XIZ 660 Z Tenere	3YF/4MY	ab 90	43F-83922-00	307102	schwarz	5,70	5Y1-83912-00	308112	schwarz	5,70
FZ 750	1FN/2KK/3KT	85-93	36Y-83922-00	307172	schwarz	5,90	1AE-83912-00	308202	schwarz	5,70
FZR 750 R	2TT	87-88	36Y-83922-00	307172	schwarz	5,90	1AE-83912-00	308202	schwarz	5,70
FZK 750 Fazer	2JE	85-93	36Y-83922-00	307172	schwarz	5,90	1AE-83912-00	308202	schwarz	5,70
XJ 750	41Y	84-85	31A-83922-00	307162	schwarz	5,90	31A-83912-00	308182	schwarz	5,90
XJ 750 Seca	11M	81-83	5G2-83922-00	307372	schwarz	8,50	5G2-83912-00	308412	schwarz	8,50
XS 750 /SE	1T5/3L3	77-80	2J2-83922-00	307132	schwarz	6,90	2H7-83912-00	308152	schwarz	5,90
XIZ 750 Super-Tenere	3LD	ab 89	43F-83922-00	307102	schwarz	5,70	5Y1-83912-00	308112	schwarz	5,70
XV 750 SE Special	5G5/5K4	81-83	2J2-83922-00	307132	schwarz	6,90	2H7-83912-00	308152	schwarz	5,90
XV 750 Virago (chrom)	4FY/4PW	ab 88	57A-83922-01	307342	Chrom	14,90	57A-83912-01	308332	Chrom	14,90
XV 750 Virago (alu)	4FY/4PW	ab 88	2W1-83922-00	307142	poliert	6,90	2GV-83912-00	308142	poliert	5,90
YZF 750 R/SP	4HN/4HT	ab 93	3GM-83922-50	307232	poliert	18,90	4FM-83912-00	308232	poliert	16,90
YZF-R 7	OW02	99-	4XV-83922-00	303192	poliert	15,30	4FM-83912-01	308232	poliert	16,90
IDM 850	3VD/4CM/4TX	91-01	3YX-83922-00	307192	poliert	8,70	3YX-83912-00	308192	poliert	6,50
TRX 850	4UN	96	3TJ-83922-00	307232	poliert	18,90	3LN-83912-00	308222	poliert	6,50
TRX 850	4UN	97-99	4SV-83922-00	307232	poliert	18,90	3LN-83912-00	308222	poliert	6,50
XS 850	4E2	ab 80	2J2-83922-00	307132	schwarz	6,90	2H7-83912-00	308152	schwarz	5,90
TDM 900	RN08	ab 02	5EB-83922-01	307272	poliert	15,30	3YX-83912-00	308192	poliert	6,50
XJ 900	31A	83-84	31A-83922-00	307162	schwarz	5,90	31A-83912-00	308182	schwarz	5,90
XJ 900 N/F	58L/4BB	85-94	36Y-83922-00	307172	schwarz	5,90	31A-83912-00	308182	schwarz	5,90
XJ 900 S Diversion	4KM	95	3YX-83922-00	307192	poliert	8,70	3YX-83912-00	308192	poliert	6,50
XJ 900 S Diversion	4KM	ab 96	3YX-83922-00	307192	poliert	8,70	4KM-83912-00	308192	poliert	6,50
XV 920 SE Virago	24N	ab 83	31A-83922-00	307162	schwarz	5,90	31A-83912-00	308182	schwarz	5,90
FZR 1000 Genesis	2LA/2GH	87-88	36Y-83922-00	307172	schwarz	5,90	1AE-83912-00	308202	schwarz	5,70
FZR 1000 Exup	3LE/3GM	89-90	3GM-83922-00	307222	poliert	6,50	3GM-83912-00	308212	poliert	6,50
FZR 1000 Exup (USD)	3LE/3GM	ab 91	3GM-83922-50	307232	poliert	18,90	3GM-83912-00	308212	poliert	6,50
FZR 1000 Exup (USD)	3LE/3GM	ab 91	3GM-83922-50	307232	poliert	18,90	verstellbar	304202	poliert	15,90
FZS 1000 Fazer	5LV	ab 01	5EB-83922-01	307272	poliert	15,30	4XV-83912-00	306232	poliert	6,00
GTS 1000 /A	4BH/4FE	ab 93	3YX-83922-00	307192	poliert	8,70	3GM-83912-00	308212	poliert	6,50
GTS 1000 /A	4BH/4FE	ab 93	3YX-83922-00	307192	poliert	8,70	verstellbar	304202	poliert	15,90
XV 1000/ TR1	5A8/19T	81-82	2J2-83922-00	307132	schwarz	6,90	2H7-83912-00	308152	schwarz	5,90
XV 1000 Midnight Special	23W	83	2J2-83922-00	307132	schwarz	6,90	10M-83912-00	308382	schwarz	8,50
XV 1000 Virago (chrom)	2AE	86-88	57A-83922-01	307342	Chrom	14,90	57A-83912-01	308332	Chrom	14,90
XV 1000 Virago (alu)	2AE	86-88	2W1-83922-00	307142	poliert	6,90	2GV-83912-00	308142	poliert	5,90
YZF 1000 Thunderace	4VD	ab 96	4SV-83922-00	307232	poliert	18,90	3GM-83912-00	308212	poliert	6,50
YZF 1000 Thunderace	4VD	ab 96	4SV-83922-00	307232	poliert	18,90	verstellbar	304202	poliert	15,90
YZF - R1	RN01/4XV	98-99	4XV-83922-00	303192	poliert	15,30	4XV-83912-00	306232	poliert	6,00
YZF - R1	RN04/5JJ	00-01	4XV-83922-00	303192	poliert	15,30	5EB-83912-01	308402	poliert	8,50
YZF - R0	RN09	02-03	4XV-83922-00	303192	poliert	15,30	5EB-83912-01	308402	poliert	8,50
YZF - R1		ab 04	5VY-83922-00	307382	poliert	39,90	4XV-83912-11	308472		in Vorb.
FJ 1100	47E	84-85	36Y-83922-00	307172	schwarz	5,90	36Y-83912-00	308422	schwarz	5,40
XS 1100 /S	2H9/5K7/3X0	78-81	2J2-83922-00	307132	schwarz	6,90	2H7-83912-00	308152	schwarz	5,90
XV 1100 Virago (chrom)	3LP	ab 89	57A-83922-01	307342	Chrom	14,90	57A-83912-01	308332	Chrom	14,90
XV 1100 Virago (alu)	3LP	ab 89	2W1-83922-00	307142	poliert	6,90	2GV-83912-00	308142	poliert	5,90
XVS 1100 Drag Star	VP05	ab 99	1FK-83922-00	307182	poliert	6,50	5BN-83912-00	308242	poliert	6,50
FJ 1200	1XJ/3CW/3YA	86-97	36Y-83922-00	307172	schwarz	5,90	1AE-83912-00	308202	schwarz	5,70
V-MAX 1200	2EN/2WE	ab 85	1FK-83922-00	307182	poliert	6,50	1FK-83912-00	308432	poliert	8,50
XJR 1200	4PU	95-98	3TJ-83922-00	307232	poliert	18,90	4FM-83912-00	308232	poliert	16,90
XVZ 1200 Venture Royal	47G	84-88	26H-83922-00	307392	schwarz	8,50	26H-83912-00	308442	schwarz	8,50
FJR 1300	RP04/5JW	01-02	5EB-83922-01	307272	poliert	15,30	5EB-83912-01	308402	poliert	8,50
FJR 1300 ABS	RP08	ab 03	5EB-83922-01	307272	poliert	15,30	5EA-83912-00	308452	poliert	39,90
XJR 1300	RP02	ab 99	3TJ-83922-00	307232	poliert	18,90	4FM-83912-00	308232	poliert	16,90
XVZ 1300 Venture Royal	3JS	89-91	26H-83922-00	307392	schwarz	8,50	26H-83912-00	308442	schwarz	8,50
XVZ 1300 A Royal Star	4YP	ab 96	4NK-83922-00	307402	poliert	10,90	4NK-83912-00	308262	poliert	8,10
XVZ 1300 AT Tour Classic	4NK	ab 99	5EY-83922-0	307272	poliert	15,30	4NK-83912-00	308262	poliert	8,10
XV 1600 Wild Star	VP08	ab 99	5EY-83922-0	307272	poliert	15,30	4WM-83912-00	308462	poliert	14,90
XV 1700 Warrior		ab 02	5EY-83922-0	307272	poliert	15,30	4WM-83912-00	308462	poliert	14,90

BELEUCHTUNG, STURZTEILE

Hebel • Levers • Leviers



Best.-Nr. 301102



Best.-Nr. 301122



Best.-Nr. 301132



Best.-Nr. 301142



Best.-Nr. 301162



Best.-Nr. 301172



Best.-Nr. 301182



Best.-Nr. 301192



Best.-Nr. 301202



Best.-Nr. 301212



Best.-Nr. 301222



Best.-Nr. 301242



Best.-Nr. 301262



Best.-Nr. 301272



Best.-Nr. 301282



Best.-Nr. 301292



Best.-Nr. 301302



Best.-Nr. 301322



Best.-Nr. 301342

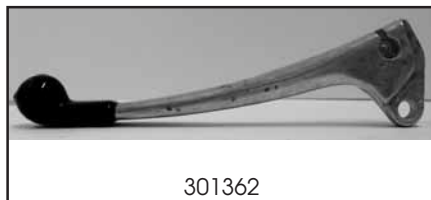

301362



Best.-Nr. 301382



Best.-Nr. 301402



Best.-Nr. 301422



Best.-Nr. 301442

BELEUCHTUNG, STURZTEILE

Hebel • Levers • Leviers



BELEUCHTUNG, STURZTEILE

Hebel • Levers • Leviers



BELEUCHTUNG, STURZTEILE

Hebel • Levers • Leviers



Best.-Nr. 303132



Best.-Nr. 303142



Best.-Nr. 303152



Best.-Nr. 303162



Best.-Nr. 303172



Best.-Nr. 303182



Best.-Nr. 303202



Best.-Nr. 303212



Best.-Nr. 303222



Best.-Nr. 303232



Best.-Nr. 303242



Best.-Nr. 303252



Best.-Nr. 303262



Best.-Nr. 303272



Best.-Nr. 303282



Best.-Nr. 303292



Best.-Nr. 303302



Best.-Nr. 303312



Best.-Nr. 304102



Best.-Nr. 304112



Best.-Nr. 304122



Best.-Nr. 304132



Best.-Nr. 304142



Best.-Nr. 304162

BELEUCHTUNG, STURZTEILE

Hebel • Levers • Leviers

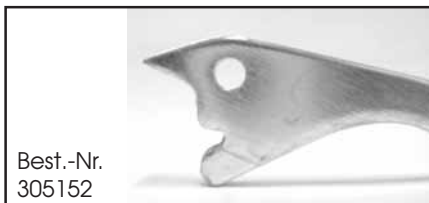

BELEUCHTUNG, STURZTEILE

Hebel • Levers • Leviers



Best.-Nr. 305202



Best.-Nr. 305212



Best.-Nr. 305222



Best.-Nr. 305232

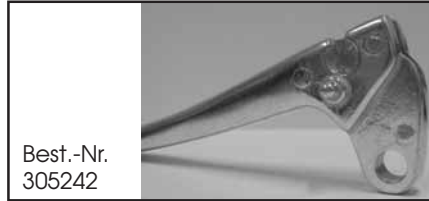

Best.-Nr. 305242



Best.-Nr. 305262



Best.-Nr. 305303



Best.-Nr. 305302



Best.-Nr. 306102



Best.-Nr. 306112



Best.-Nr. 306122



Best.-Nr. 306132



Best.-Nr. 306142



Best.-Nr. 306152



Best.-Nr. 306162



Best.-Nr. 306172



Best.-Nr. 306182



Best.-Nr. 306192



Best.-Nr. 306202



Best.-Nr. 306212



Best.-Nr. 306222



Best.-Nr. 306232



Best.-Nr. 306242



Best.-Nr. 306252

BELEUCHTUNG, STURZTEILE

Hebel • Levers • Leviers

Best.-Nr.
306262



Best.-Nr.
306272



Best.-Nr.
306282



Best.-Nr.
306292



Best.-Nr.
306302



Best.-Nr.
306312



Best.-Nr.
306322



Best.-Nr.
306332



Best.-Nr.
306342



Best.-Nr.
307102



Best.-Nr.
307112



Best.-Nr.
307122



Best.-Nr.
307132



Best.-Nr.
307142



Best.-Nr.
307152



Best.-Nr.
307162



Best.-Nr.
307182



Best.-Nr.
307192



Best.-Nr. 307202



Best.-Nr. 307222



Best.-Nr. 307232



Best.-Nr. 307242



Best.-Nr.
307252



Best.-Nr. 307262



BELEUCHTUNG, STURZTEILE

Hebel • Levers • Leviers



BELEUCHTUNG, STURZTEILE

Hebel • Levers • Leviers

Best.-Nr.
308212



Best.-Nr.
308222



Best.-Nr.
308232



Best.-Nr. 308252



Best.-Nr.
308262



Best.-Nr.
308272



Best.-Nr.
308282



Best.-Nr.
308292



Best.-Nr.
308302



Best.-Nr.
308322



Best.-Nr.
308332



Best.-Nr.
308342



Best.-Nr.
308352



Best.-Nr.
308362



Best.-Nr.
308372



Best.-Nr.
308382



Best.-Nr.
308392



Best.-Nr.
308402



Best.-Nr.
308422



Best.-Nr.
308432



Best.-Nr.
308442



Best.-Nr.
308462



Best.-Nr.
309101



Best.-Nr.
309102





Hebel 2006:

